

DVD PLAYER

DVD-S520/DV-S5450

SERVICE MANUAL

DVD-S520/DV-S5450

IMPORTANT NOTICE

This manual has been provided for the use of authorized YAMAHA Retailers and their service personnel. It has been assumed that basic service procedures inherent to the industry, and more specifically YAMAHA Products, are already known and understood by the users, and have therefore not been restated.

WARNING: Failure to follow appropriate service and safety procedures when servicing this product may result in personal injury, destruction of expensive components, and failure of the product to perform as specified. For these reasons, we advise all YAMAHA product owners that any service required should be performed by an authorized YAMAHA Retailer or the appointed service representative.

IMPORTANT: The presentation or sale of this manual to any individual or firm does not constitute authorization, certification or recognition of any applicable technical capabilities, or establish a principle-agent relationship of any form.

The data provided is believed to be accurate and applicable to the unit(s) indicated on the cover. The research, engineering, and service departments of YAMAHA are continually striving to improve YAMAHA products. Modifications are, therefore, inevitable and specifications are subject to change without notice or obligation to retrofit. Should any discrepancy appear to exist, please contact the distributor's Service Division.

WARNING: Static discharges can destroy expensive components. Discharge any static electricity your body may have accumulated by grounding yourself to the ground buss in the unit (heavy gauge black wires connect to this buss).

IMPORTANT: Turn the unit OFF during disassembly and part replacement. Recheck all work before you apply power to the unit.

CONTENTS

TO SERVICE PERSONNEL	1	INTERACTIVE TESTS	12~18
WARNINGS	1~2	TEST INSTRUCTIONS	18~21
PREVENTION OF ELECTRO STATIC DISCHARGE	3	TROUBLESHOOTING	22~28
LOCALE MANAGEMENT INFORMATION	3	TECHNICAL SPECIFICATIONS DVD MODULE	29~30
FRONT PANELS	4	LIST OF ABBREVIATIONS	31
REMOTE CONTROL TRANSMITTER	4	IC DESCRIPTIONS	32~41
REAR PANELS	5~6	WIRING DIAGRAM	42
SPECIFICATIONS	6~7	BLOCK DIAGRAM	43~44
DISASSEMBLY PROCEDURES	8	PRINTED CIRCUIT BOARD	45~65
SERVICE POSITION	9	SCHEMATIC DIAGRAM	65~77
SERVICE HINTS	9	PARTS LIST	78~87
DIAGNOSTIC SOFTWARE: SCRIPT INTERFACES	10~11	REMOTE CONTROL TRANSMITTER	88



このサービスマニュアルは、エコマーク認定の再生紙を使用しています。
This Service Manual uses recycled paper.

■ TO SERVICE PERSONNEL

1. Critical Components Information
Components having special characteristics are marked  and must be replaced with parts having specifications equal to those originally installed.
2. Leakage Current Measurement (For 120V Models Only)
When service has been completed, it is imperative to verify that all exposed conductive surfaces are properly insulated from supply circuits.
 - Meter impedance should be equivalent to 1500 ohm shunted by 0.15 μ F.
 - Leakage current must not exceed 0.5mA.
 - Be sure to test for leakage with the AC plug in both polarities.

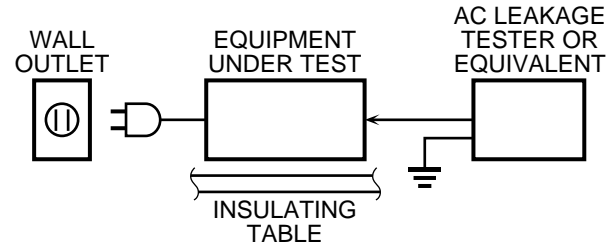

THE DVD PLAYER SHOULD NOT BE ADJUSTED OR REPAIRED BY ANYONE EXCEPT PROPERLY QUALIFIED SERVICE PERSONNEL.

■ WARNINGS

WARNING: CHEMICAL CONTENT NOTICE!

The solder used in the production of this product contains LEAD. In addition, other electrical/electronic and /or plastic (where applicable) components may also contain traces of chemicals found by the California Health and Welfare Agency (and possibly other entities) to cause cancer and/or birth defects or other reproductive harm.

DO NOT PLACE SOLDER, ELECTRICAL/ELECTRONIC OR PLASTIC COMPONENTS IN YOUR MOUTH FOR ANY REASON WHATSOEVER!

Avoid prolonged, unprotected contact between solder and your skin! When soldering, do not inhale solder fumes or expose eyes to solder/flux vapor!

If you come in contact with solder or components located inside the enclosure of this product, wash your hands before handling food.

WARNING: Laser Safety

This product contains a laser beam component. This component may emit invisible, as well as visible radiation, which may cause eye damage. To protect your eyes and skin from laser radiation, the following precautions must be used during servicing of the unit.

- 1) When testing and/or repairing any component within the product, keep your eyes and skin more than 30 cm away from the laser pick-up unit at all times. Do not stare at the laser beam at any time.
- 2) Do not attempt to readjust, disassemble or repair the laser pick-up, unless noted elsewhere in this manual.
- 3) CAUTION: Use of controls, adjustments or performance of procedures other than those specified herein may result in hazardous radiation exposure.

Laser Emitting conditions:

- 1) When the Top Cover is removed and the "POWER" SW is turned to the "ON" position, the laser component will emit a beam for several seconds to detect if a disc is present. During this time (5 - 10 sec.) the laser may radiate through the lens of the laser pick-up unit. Do not attempt any servicing during this period!
If no disc is detected, the laser will stop emitting the beam. When a disc is loaded, you will not be exposed to any laser emissions.
- 2) The laser power level can be adjusted with the VR on the pick-up PWB. However, this level has been set by the factory prior to shipping from the factory. Do not adjust this laser level control unless instruction is provided elsewhere in this manual.
Adjustment of this control can increase the laser emission level from the device.

Laser Diode Properties

Type:	Semiconductor laser GaAlAs
Wave length:	650 nm (DVD) 780 nm (VCD/CD)
Output Power:	7 mW (DVD) 10 mW (VCD/CD)
Beam divergence:	60 degree

Output value is determined by CFR CHAPTER1, SUBCHAPTER J

VARO!	: AVATTAESSA JA SUOJALUKITUS OHITETTAESSA OLET ALTTIINA NÄKYMÄTTÖMÄLLE LASER-SÄTEILYLLE. ÄLÄ KATSO SÄTEESEEN.
WARNING!	: OSYNLIG LASERSTRÅLNING NÄR DENNA DEL ÄR ÖPPNAD OCH SPÄRREN ÄR URKOPPLAD. BETRAKTA EJ STRÅLEN.

WARNING

The use of optical instruments with this product will increase eye hazard.
Repair handling should take place as much as possible with a disc loaded inside the player

U, C models

DANGER - Visible and invisible laser radiation when open. Avoid direct exposure to beam.



R, A, T, P models

CAUTION - Visible and invisible laser radiation when open. Avoid exposure to beam.



CLASS 1 LASER PRODUCT
LASER KLASSE 1 PRODUKT
LUOKAN 1 LASERLAITE
KLASS 1 LASER APPART

B, G models

CAUTION - Visible and invisible laser radiation when open. Avoid exposure to beam.

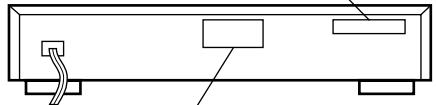

CLASS 1 LASER PRODUCT
LASER KLASSE 1 PRODUKT
LUOKAN 1 LASERLAITE
KLASS 1 LASER APPART

WARNING LOCATION: REAR PANEL

CAUTION VISIBLE AND INVISIBLE LASER RADIATION WHEN OPEN. AVOID EXPOSURE TO BEAM
ADVARSEL SYNLIG OG USYNLIG LASERSTRÅLING VED ÅBNING UNDGÅ UDSÆTTELSE FOR STRÅLING
ADVARSEL SYNLIG OG USYNLIG LASERSTRÅLING NÄR DEKSEL ÅPNES UNNGÅ EKSPONERING FOR STRÅLEN
WARNING SYNLIG OCH OSYNLIG LASERSTRÅLNING NÄR DENNA DEL ÄR ÖPPNAD BETRAKTA EJ STRÅLEN
VARO! AVATT AESSA OLET ALTTIINA NÄKYVÄLLE JA NÄKYMÄTTÖMÄLLE LASER SÄTEILYLLE. ÄLÄ KATSO SÄTEESEEN
VORSICHT SICHTBARE UND UNSICHTBARE LASERSTRAHLUNG WENN ABDECKUNG GEÖFFNET NICHT DEM STRAHL AUSSETZEN
DANGER VISIBLE AND INVISIBLE LASER RADIATION WHEN OPEN. AVOID DIRECT EXPOSURE TO BEAM
ATTENTION RAYONNEMENT LASER VISIBLE ET INVISIBLE EN CAS D'OUVERTURE EXPOSITION DANGEREUSE AU FAISCEAU

Warning for power supply

The primary side of the power supply including the heatsink carries live mains voltage when the player is connected to the mains even when the player is switched off !

This primary area is not shielded so it is possible to touch copper tracks and/or components when servicing the player. Service personnel have to take precautions to prevent touching this area or components in this area .

The primary side of the power supply has been indicated with a lightning stroke and a stripe-marked print on the printed wiring board

Note:

The screws on the DVD mechanism (position 18-1 in on the exploded view drawing) may never be touched, removed or re-adjusted.

Handle the DVD mechanism with care when the unit has to be exchanged!

The DVD mechanism is very sensitive for dropping or giving shocks.

■ PREVENTION OF ELECTRO STATIC DISCHARGE

The laser diode in the traverse unit (optical pickup) may be damaged due to static electricity from clothes or the human body. Use caution to prevent electrostatic damage when servicing or handling the laser diode.

1. Grounding for electrostatic damage prevention

Some devices, such as the DVD player, use an optical pickup (laser diode) that will be damaged by static electricity in the working environment. Only attempt service after ensuring that all grounding procedures have been completed.

1. Worktable grounding

Put a grounded conductive material (sheet) or iron sheet on the area where the optical pickup is placed.

2. Human body grounding

Use an anti-static wrist strap to discharge the static electricity from your body.

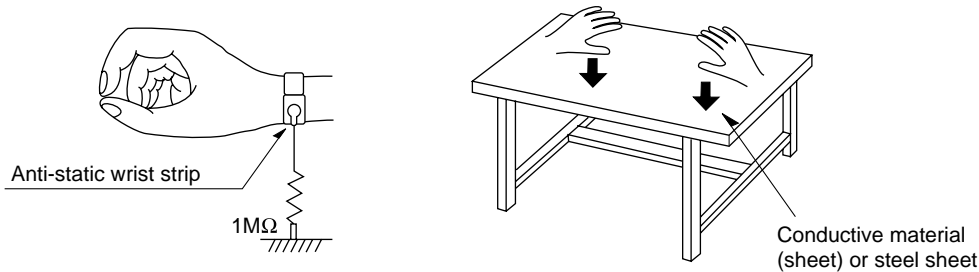

2. Handling of the optical pickup

1. To prevent damage to the optical pickup replacement parts during transportation and before installation, both ends of the laser diode are short-circuited. After installing the new part, remove the short circuit according to the correct procedure in this service manual.
2. Do not use a tester to check the laser diode in the optical pickup. The power supply in the tester will damage the laser diode.

3. Handling Precautions for the Traverse Unit (Optical Pickup)

1. Handle the traverse unit (optical pickup) gently, as it is an extremely high-precision assembly.
2. When replacing the optical pickup, install the flexible cable and cut its short land with wire cutters. See the optical pickup replacement procedure in this service manual. Before replacing the traverse unit, remove the shorting pin for preventing static electricity damage and install the new unit. Reconnect the connector as quickly as possible.
3. The flexible cable lines may break if an excessive force is applied to it. Use caution when handling the cable.
4. The semi-fixed resistor for laser power adjustment should not be adjusted. Do not turn the resistor.

■ LOCALE MANAGEMENT INFORMATION

Locale Management Information : This DVD player is designed and manufactured to respond to the Locale Management Information that is recorded on the DVD disc. If the Locale number described on the DVD disc does not correspond to the Locale number of this DVD player, this DVD player cannot play this disc.

This product incorporates copyright protection technology that is protected by method claims of certain U.S. patents and other intellectual property rights owned by Macrovision Corporation and other rights owners. Use of this copyright protection technology must be authorized by Macrovision Corporation, and is intended for home and other limited viewing uses only unless otherwise authorized by Macrovision Corporation. Reverse engineering or disassembly is prohibited.

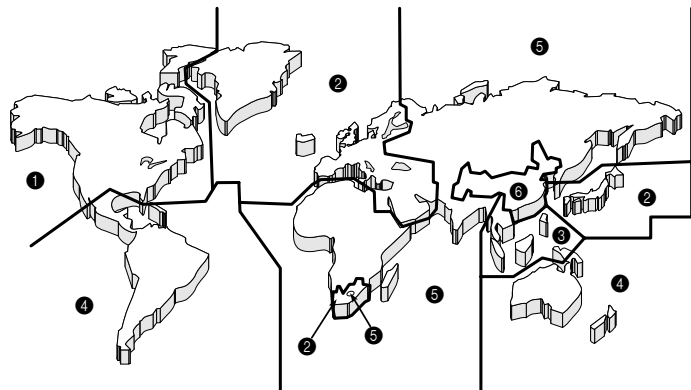

FRONT PANELS

DVD-S520

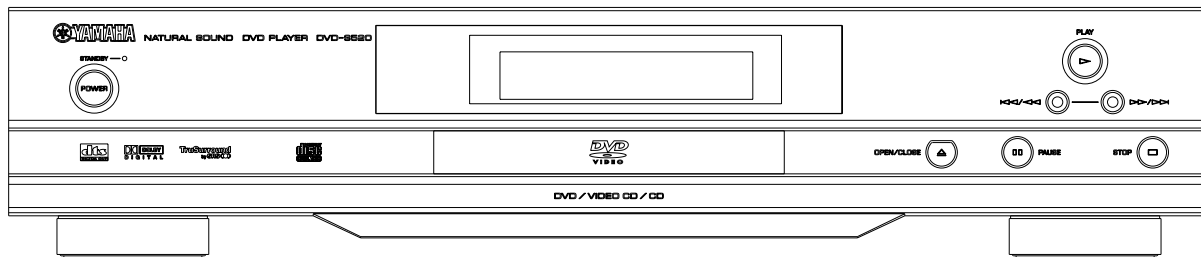

DV-S5450

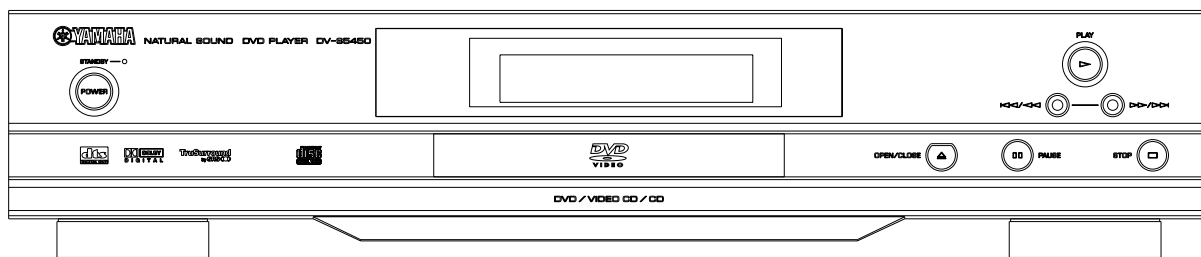

REMOTE CONTROL TRANSMITTER

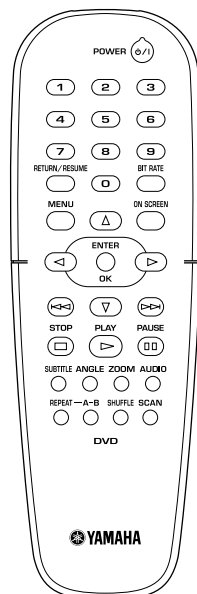

DVD-S520/DV-S5450

REAR PANELS

DVD-S520 U, C models

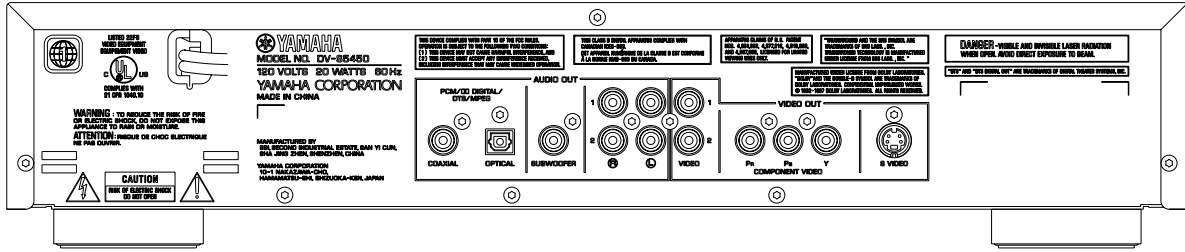

DVD-S520 A model

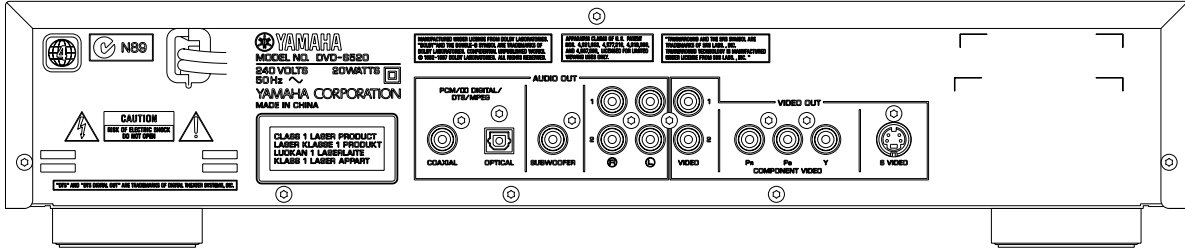

DVD-S520 B, G models

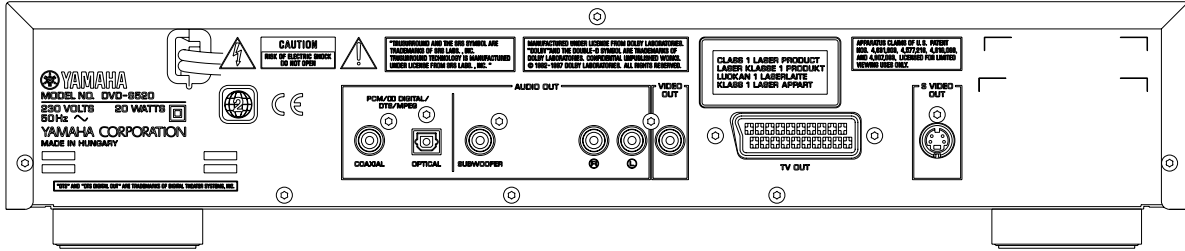

DVD-S520 R model

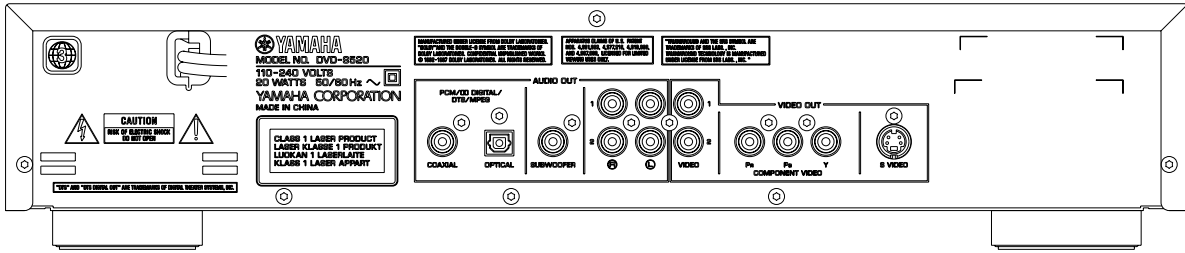

DVD-S520 T model

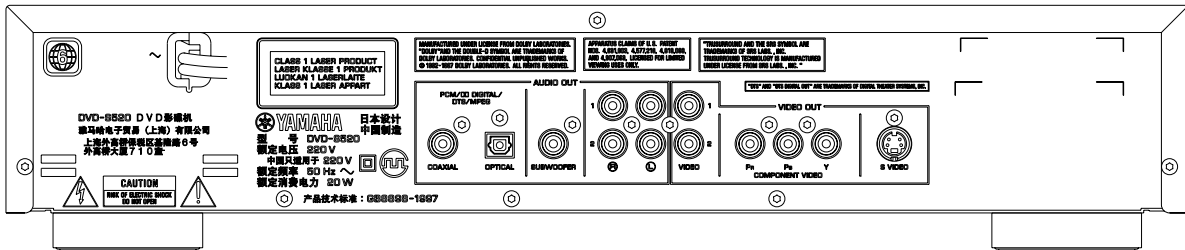

DVD-S520 P model

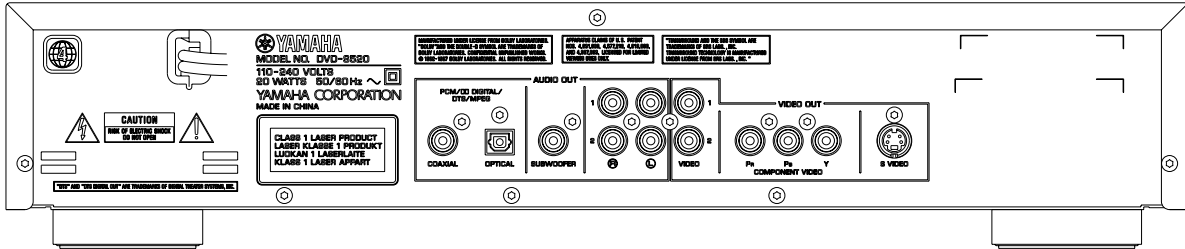

DV-S5450 U model

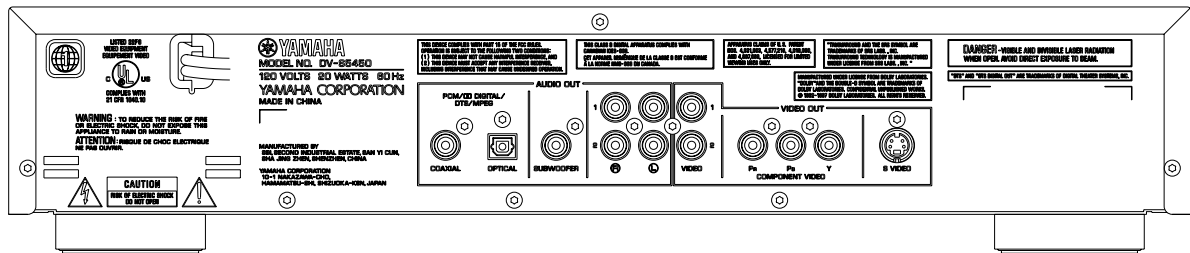

DV-S5450 A model

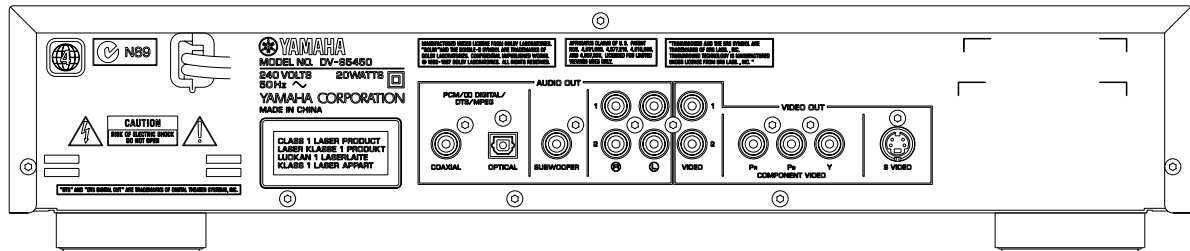

■ SPECIFICATIONS

PLAYBACK SYSTEM

DVD Video
Video CD & SVCD
CD (CD Recordable and CD Rewritable)
DVD+RW
MP3

OPTICAL READOUT SYSTEM

Lasertype Semiconductor AIGaAs
Numerical Aperture 0.60 (DVD)
0.45 (VCD/CD)
Wavelength 650 nm (DVD)
780 nm (VCD/CD)

DVD DISC FORMAT

Medium	Optical Disc	
Diameter	12cm (8cm)	
Playing time (12cm)	One layer	2.15 h*
	Dual layer	4 h*
	Two side	4.30 h*
	Single layer	
	Two side	8 h*
Dual layer		

VIDEO FORMAT

DA Converter	10 bits
Signal handling	Components
Digital Compression	MPEG2 for DVD
	MPEG1 for VCD

TV STANDARD (PAL/50Hz) (NTSC/60Hz)

Number of lines	625	525
Playback	Multistandard	(PAL/NTSC)

DVD

Horizontal Resolution	720 pixels	720 pixels
Vertical Resolution	576 lines	480 lines

VCD

Horizontal Resolution	352 pixels	352 pixels
Vertical Resolution	288 lines	240 lines

VIDEO PERFORMANCE

Video output	1 Vpp into 75 ohm
S-Video output	Y: 1 Vpp into 75 ohm C: 0.3 Vpp into 75 ohm
Component video output	Y: 1 Vpp into 75 ohm (U, C, A, R, T, P) Pb/Cb Pr/Cr: 0.7Vpp into 75 ohm (U, C, A, R, T, P)
RGB (SCART) output	0.7 Vpp into 75 ohm (B, G)
Black Level Shift	On/Off
Video Shift	Left/Right

AUDIO FORMAT

Digital	MPEG	Compressed Digital
	DTS/Dolby Digital	
	PCM	16, 20, 24 bits fs, 44.1, 48, 96 kHz

Analog Sound Stereo
Dolby Pro Logic downmix from Dolby Digital multi-channel sound
3D Sound (TruSurround) for virtual 5.1 channel sound on 2 speakers

AUDIO PERFORMANCE

DA Converter	24 bits	
DVD	fs 96 kHz	2 Hz 44 kHz
	fs 48 kHz	2 Hz 22 kHz
Video CD	fs 44.1 kHz	2 Hz 20 kHz
CD	fs 44.1 kHz	2 Hz 20 kHz
Signal-Noise (1kHz)		95 dB
Dynamic Range (1kHz)		95 dB
Harmonic Distortion and Noise (1kHz)		0.0035 %
MPEG MP3		MPEG Audio L3

CONNECTIONS

Y Output	Cinch (green) (U, C, A, R, T, P)
Pb/Cb Output	Cinch (blue) (U, C, A, R, T, P)
Pr/Cr Output	Cinch (red) (U, C, A, R, T, P)
SCART	Euroconnector (B, G)
S-Video Output	Mini DIN, 4 pins
Video Output	Cinch (yellow)
Audio L+R output	Cinch (white/red)
Subwoofer output	Cinch (black)
Digital Output	1 coaxial, 1 optical IEC958 for CDDA / LPCM IEC1937 for MPEG1/2, Dolby Digital and DTS

GENERAL

Dimensions(w x h x d) 435 x 91 x 314 mm
 (17-1/8" x 3-5/8" x 12-9/16")
 Weight Approx. 3.3 Kg (7 lbs. 4.5 oz.)
 Finish DVD-S520 Black color (U, C, A, B, G, P)
 Gold color (R, G, T)
 DV-S5450 Titan color (G, B)
 Black color (U, A)
 Silver color (U)
 Power supply 120 V, 60 Hz (U, C)
 230 V, 50 Hz (B, G)
 240 V, 50 Hz (A)
 110–240 V, 50/60 Hz (R)
 220 V, 50 Hz (T)
 Power consumption 20 W
 Standby power consumption (reference data) 5 W

PACKAGE CONTENTS

DVD-Video Player, Remote Control & Batteries,
 Owner's Manual, Audio/Video cable (U, C, A, R, T),
 Audio cable (B, G), Video cable (B, G)

GENERAL FUNCTIONALITY

Stop / Play / Pause
 Fast Forward / Backward
 Time Search
 Step Forward / Backward
 Slow Motion
 Title / Chapter / Track Select
 Skip Next / Previous
 Repeat (Chapter / Title / All) or (Track / All)
 A-B Repeat
 Shuffle
 Scan
 New enhanced user graphical interface
 Zoom (x1.33, x2, x4) with picture enhancement
 Smart Picture for convenient personal colour setting
 NTSC/PAL Conversion
 Screen Saver (Dim 75% after 15 min.)
 3D Sound (TruSurround)
 Audio and video bit rate indicator

DVD FUNCTIONALITY

Multi-angle Selection
 Audio Selection (1 out of maximum 8 languages)
 Subtitles Selection (1 out of maximum 32 languages)
 Aspect Ratio conversion (16:9, 4:3 Letterbox, 4:3 Pan Scan)
 Parental Control and Child Lock
 Disc Menu support (Title Menu and Access Control)
 Resume (5 discs) after stop / standby
 Programming Titles/chapters with Favourite Track Selection

VIDEO CD FUNCTIONALITY

Playback Control for VCD 2.0 discs
 Child Lock
 Resume (5 discs) after stop / standby
 Programming Tracks with Favourite Track Selection

AUDIO CD FUNCTIONALITY

Time Display (Total / Track)
 Full audio functionality with remote control
 Programming with Favourite Track Selection

MP3 FUNCTIONALITY

Time Display (Track)
 Album and Track Selection
 Repeat (Disc / Album / Track)

* typical playing time for movie with 2 spoken languages and 3 subtitle languages.

Specifications subject to change without prior notice

- | | | | |
|----------------|------------------------|----------------|----------------------------|
| U | U.S.A. model | C | Canada model |
| G | Europe model | B | British model |
| A | Australia model | R | General model |
| T | China model | P | South America model |

DVD-S520/DV-S5450

TruSurround and the SRS symbol are trademarks of SRS Labs., Inc. TruSurround technology is incorporated under license from SRS Labs., Inc.



Manufactured under license from Dolby Laboratories. "Dolby" and the double-D symbol are trademarks of Dolby Laboratories.

"DTS" and "DTS Digital Surround" are trademarks of Digital Theater Systems, Inc.

This product incorporates copyright protection technology that is protected by method claims of certain U.S. patents and other intellectual property rights owned by Macrovision Corporation and other rights owners. Use of this copyright protection technology must be authorized by Macrovision Corporation, and is intended for home and other limited viewing uses only unless otherwise authorized by Macrovision Corporation. Reverse engineering or disassembly is prohibited.

DISASSEMBLY PROCEDURES

See exploded view for item numbers.

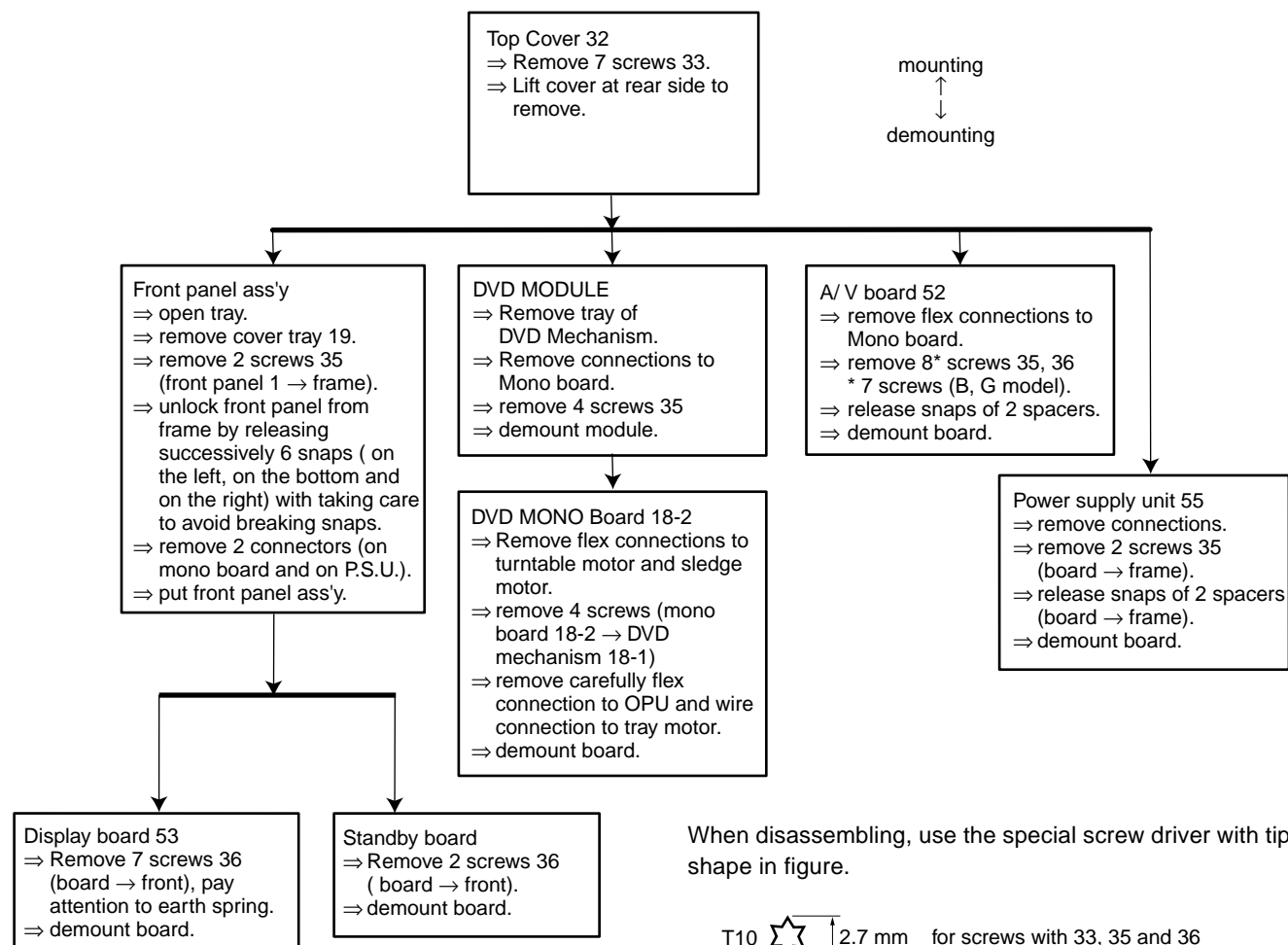

When disassembling, use the special screw driver with tip shape in figure.

T10  2.7 mm for screws with 33, 35 and 36

T6  1.7 mm for removing MONO board (18-2) from DVD Mechanism (18-1)

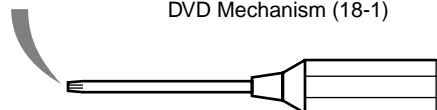

● The way to remove tray

1. Push left end of the lever under the tray toward the right by using screwdriver, move the tray by pulling it forward. (Fig. 1)
2. While lifting up the lever (①), move the left side of the tray by pulling it forward (②). (Fig. 2)
3. While lifting up the tray (③), remove the tray by pulling it forward (④). (Fig. 2)

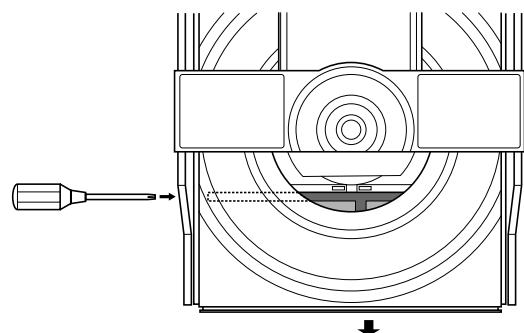

Fig. 1

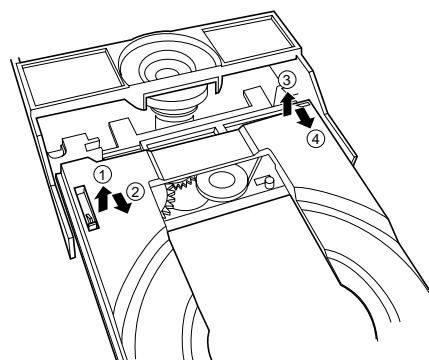

Fig. 2

■ SERVICE POSITION

See figure 1 for the service position

1. Remove the cables from the cable tie housing.
2. Remove 4 screws that mount the DVD module to the bottom frame.
3. Move the DVD module backward slightly and flip the module over, so that the component side of the board faces upwards, and the module is in the service position.

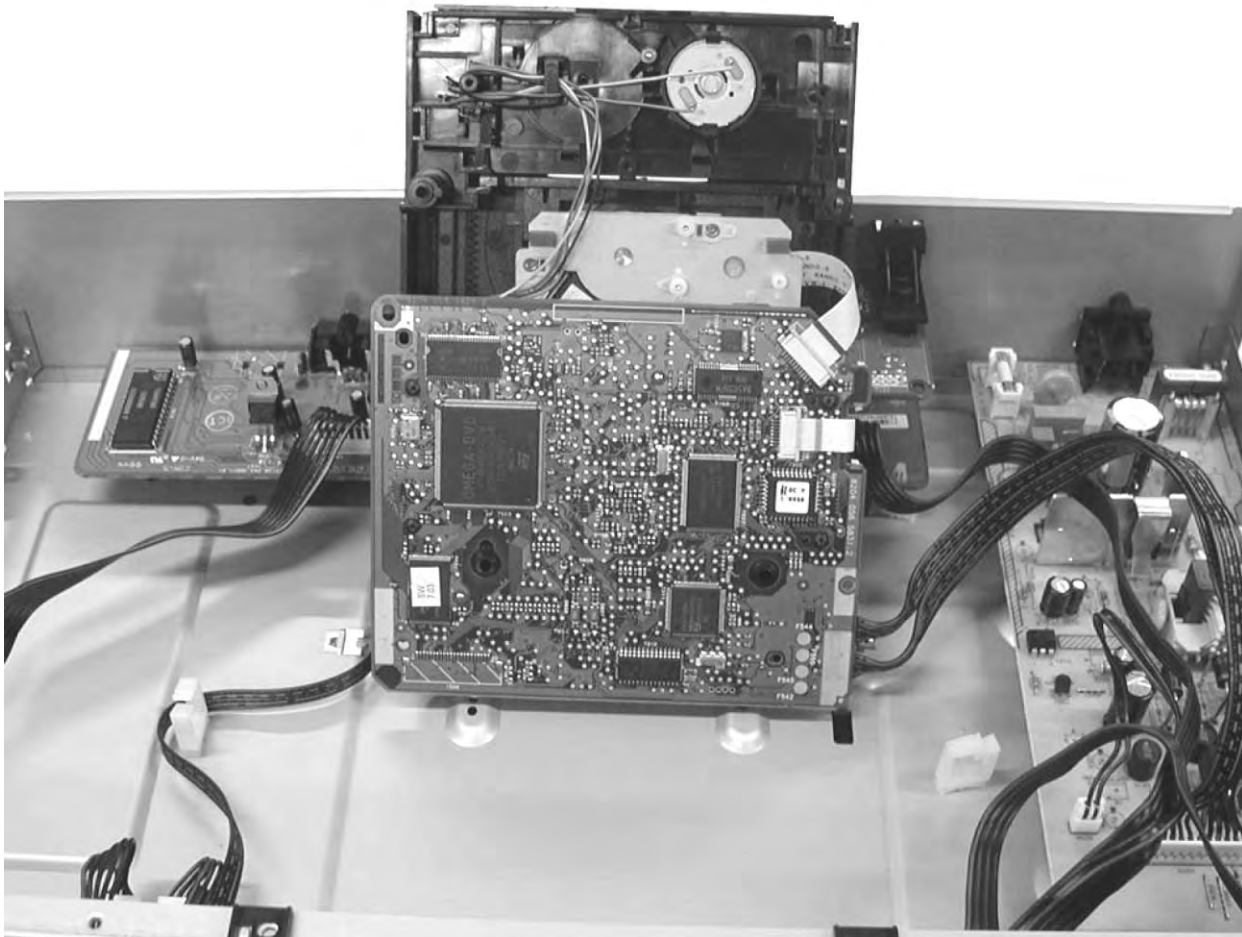

Fig. 1

■ SERVICE HINTS

Diagnostic software

In chapter "Diagnostic software", some tests are referring to the SCART functionality.

These tests are for sets with RGB-output.

For sets without RGB-output, no SCART connector is mounted.

In these sets, the SCART tests will automatically be skipped.

■ DIAGNOSTIC SOFTWARE : SCRIPT INTERFACES

1. DEALER SCRIPT

1.1 Purpose of Dealer Script

The dealer script can give a diagnosis on a standalone DVD player; no other equipment is needed to perform a number of hardware tests to check if the DVD player is faulty. The diagnosis is simply a "error" or "pass" message; no indication is given of faulty hardware modules. Only tests within the scope of the diagnostic software will be executed hence only faults within this scope can be detected.

1.2 Contents of Dealer Script

The dealer script executes all diagnostic nuclei that do not need any user interaction and are meaningful on a standalone DVD player.

The nuclei called in the dealer script are the following (the number after each nucleus name corresponds with the number being on the local display when the nucleus is executed during the dealer script):

Nucleus		Description
VideoColSetupComm	9	Checks the I2C interface with the RGB video processor on the Audio/Video board (only for DVD players with RGB video processor).
VideoScartSwComm	8	Checks the I2C interface with the scart switch on the Audio/Video board
PapChksFl	7	Calculate and verify checksum of FLASH memory.
PapDramWrR	6	Pattern test of all locations in the DRAM(s).
PapI2cDisp	5	Checks the I2C interface with the slave processor on the display PCB.
PapS2bEcho	4	Checks the I2C interface to the basic engine.
PapI2cNvram	3	Checks the I2C interface with the NVRAM.
PapNvramWrR	2	Pattern test of all locations in the NVRAM
CompSdramWrR	1	Pattern test of all locations in the SDRAM(s).

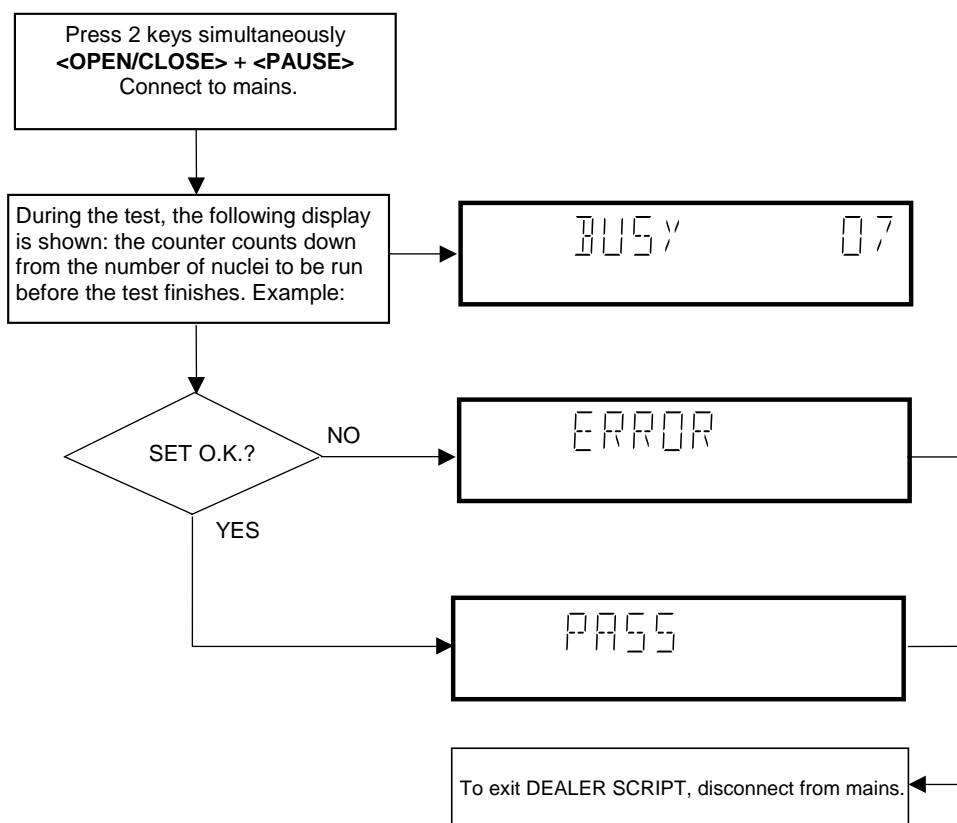

2. PLAYER SCRIPT

2.1 Purpose of Player Script

The Player script will give the opportunity to perform a test that will determine which of the DVD player's modules are faulty, to read the error log and error bits and to perform an endurance loop test. To successfully perform the tests, the DVD player must be connected to a TV set to check the output of a number of nuclei. For DVDv2b a multi-channel amplifier, a set of 6 boxes and an external video source are necessary to test. To be able to check results of certain nuclei, the player script expects some interaction of the user (i.e. to approve a test picture or a test sound). Some nuclei (e.g. nuclei that test functionality of the Basic Engine module) require that the DVD player itself is opened, to enable the user to observe moving parts and approve their movement visually. Only tests within the scope of the diagnostic software will be executed hence only faults within this scope can be detected.

2.2 Contents of Player Script

The player script contains all nuclei that are useful on a DVD player that is connected to a TV-set and help to determine which module of the DVD player is faulty, as well as to read out the contents of the error logs.

2.3 Structure of Player Script

The player script consists of a set of nuclei testing the three hardware modules in the DVD player: the Display PWB, the Digital PWB and the Basic Engine.

Nuclei run by the player test need some user interaction; in the next paragraph this interaction is described. The player test is done in two phases:

1. Interactive tests: this part of the player test depends strongly on user interaction and input to determine nucleus results and to progress through the full test. Reading the error log and error bits information can be useful to determine any errors that occurred recently during normal operation of the DVD player.
2. The loop test will loop through the list of nuclei indefinitely, till the NEXT key is pressed. The list of nuclei is as follows:
 - VideoColSetupComm
 - VideoScartSwComm
 - PapChksFlash
 - PapI2cNvram
 - CompSdramWrR
 - PapS2bEcho
 - PapI2cDisp

For DSW version 1.6 and above. the DSW version number will be displayed on the local display. Press NEXT to continue to the display test.

The display should look like the following:

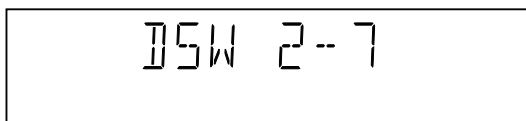

2.4 Survey

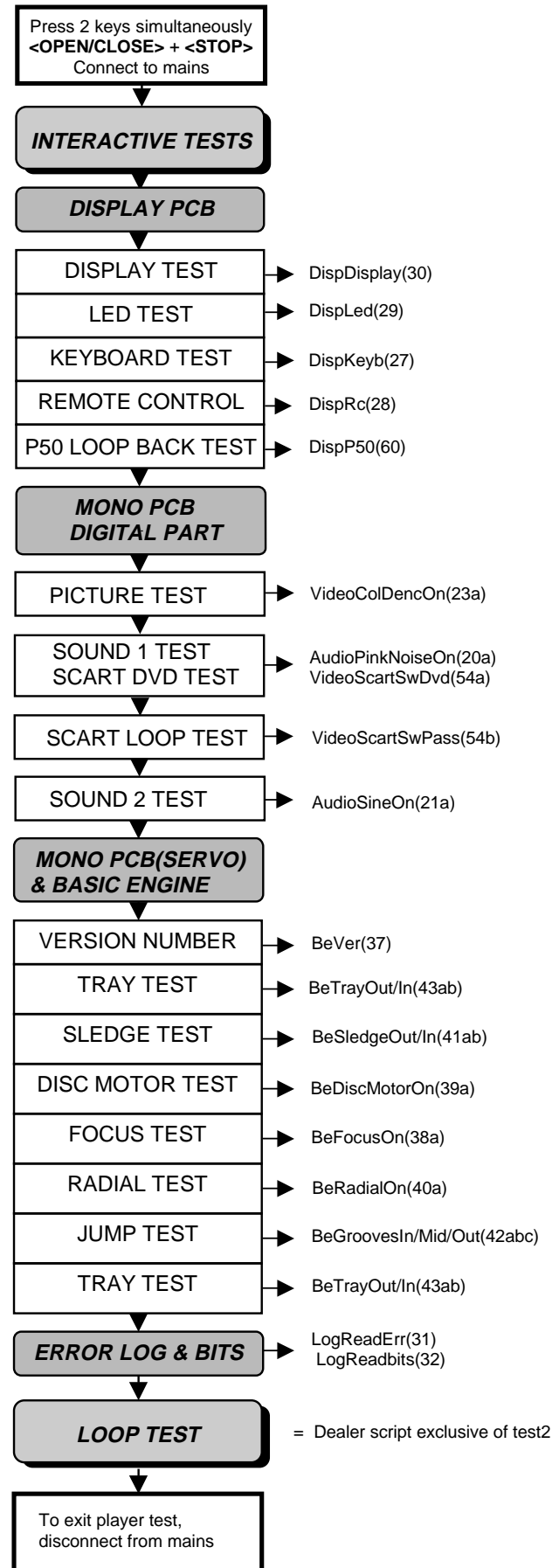

■ INTERACTIVE TESTS

1. DISPLAY PCB

1.1 DISPLAY TEST

The display test is performed by nucleus DispDisplay. By putting a series of test patterns on the local display, the local display is tested. To step through all different patterns, the user must either press PLAY (pattern is ok) or PAUSE (pattern was incorrect) to proceed to the next pattern. The display of patterns is continued in a cyclic manner until the user presses NEXT. If the user presses NEXT before all display patterns are tested, the DispDisplay nucleus will return TRUE (display test successful).

1.2 LED TEST

The LED(s) on the DVD player is (are) tested by nucleus DispLed. The user must check if the LED(s) is (are) lighted; if it is, press PLAY, if it is not, press PAUSE. By pressing NEXT the script will proceed to the next test. If the user presses NEXT before PLAY or PAUSE, the DispLed nucleus will return TRUE (LED test successful).

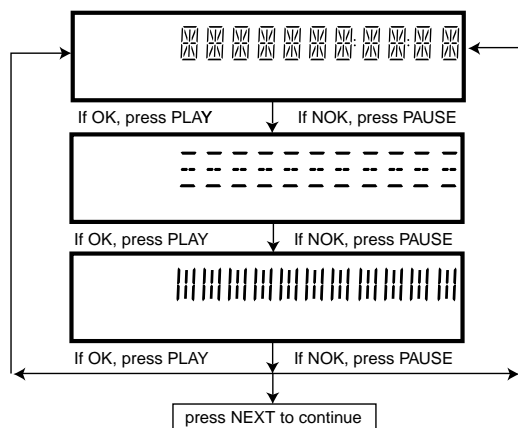

Figure 1

1.3 KEYBOARD TEST

The keyboard of the DVD player is tested by nucleus DispKeyb. The user is expected to press all keys on the local keyboard once. The code of the key pressed is shown on the local display (1 hexadecimal digit) immediately followed by a (hexadecimal) number indicating how many times that key has been pressed. Example of the local display during this test:

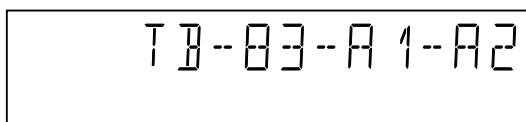

Figure 2

The key-codes displayed on the local display will scroll from right to left when the display gets full, the text "tb-" will remain on display.

key id.	key
0	PLAY ▶
1	NEXT ▷▷/▷▷
2	PREVIOUS ◀◀/◀◀
3	PAUSE □□
4	STOP □
5	OPEN/CLOSE ▲
A	POWER (B,G models)

Figure 3

If any keys are detected more than once (due to hardware error), the key-code is displayed twice (or more), with the second digit increased by 1.

If the user does not press all keys minimally once (in any order), the DispKeys nucleus will return FALSE and cause an error in the overall result of the player script.

The user can leave the keyboard test by pressing the NEXT key on the local display of the DVD player for at least one full second.

The result of the keyboard test is shown on local display as follows:

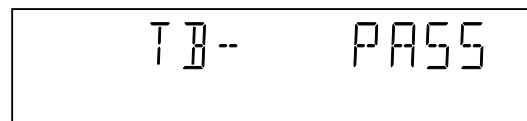

Figure 4

Or

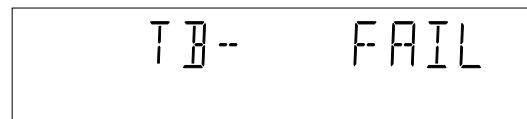

Figure 5

Pressing NEXT on the local keyboard again will proceed to the next text.

1.4 REMOTE CONTROL TEST

The remote control of the DVD player is tested by nucleus DispRc. The user must press any key on the remote control just once. The codes of the key pressed will be shown on the local display in hexadecimal format. Example:

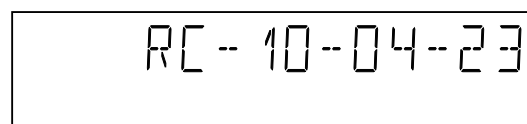

Figure 6

In this example 23 is the hexadecimal code of the pressed RC key. The user can leave the remote-control test by pressing NEXT on the local keyboard of the DVD player. The remote control test is successful if a code was received before the user pressed the NEXT key; pressing the NEXT key before pressing a key on the remote control gives an error in the remote control test (note that the remote control test will also fail if a key on the remote control was pressed but no code was received). The remote control test does not check upon the contents of the received code, that is it will not be checked if the received code matches the key pressed. If desired, the user can manually check this code by using a code-table for the remote control key-codes.

RC Key id	Hexadecimal code
POWER	C
1	1
2	2
3	3
4	4
5	5
6	6
7	7
8	8
9	9
RETURN/RESUME	83
0	0
BIT RATE	EF
MENU	54
CURSOR UP	58
ON SCREEN	82
CURSOR LEFT	5A
OK	5C
CURSOR RIGHT	5B
PREVIOUS	21
CURSOR DOWN	21
NEXT	20
STOP	31
PLAY	2C
PAUSE	30
SUBTITLE	4B
ANGLE	85
ZOOM	F7
AUDIO	4E
REPEAT	1D
A/B REPEAT	3B
SHUFFLE	1C
SCAN	2A

Figure 7

After pressing NEXT, the result of the remote control test is displayed on the local display of the DVD player as follows:



Figure 8

Or



Figure 9

Pressing NEXT on the local keyboard again will proceed to the next test.

1.5 P50 Loop-Back Test

For the P50 loop-back test, the user must first press a key to decide if the test is to be performed.

The display will show the following message:



Figure 10

If the user presses PAUSE, the P50 test will be skipped. If the user presses PLAY, the P50 test is performed and the result is displayed as follows:

Test successful:

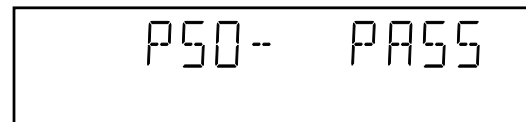

Figure 11

Test fails:

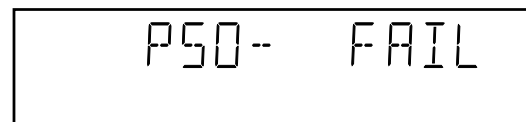

Figure 12

Press the NEXT key to continue to the next text

2 MONO PCB DIGITAL PART

2.1 PICTURE TEST

The picture test is performed by putting a predefined picture (colour bar) on the display (nucleus

DVD-S520/DV-S5450

VideoColDencOn) and asking the user for confirmation. The display shows the following message:

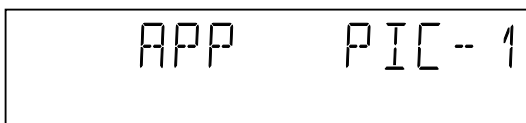

Figure 13

By pressing PLAY, the user confirms the test; pressing PAUSE will indicate the picture was invisible or incorrect. Pressing NEXT will proceed to the next test

2.2 SOUND 1 & SCART DVD TEST

The first soundtest is performed by starting a pink noise sound that needs confirmation from the user (nucleus AudioPinkNoiseOn); the display shows the following message very shortly:

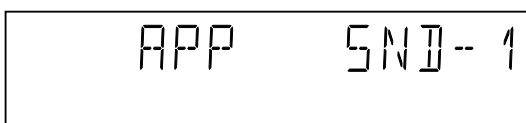

Figure 14

This sound will only be audible from version cut3.1 of Sti5505(item7503 on mono board) onwards. After starting up sound 1, SCART loop-trough will be simultaneously active during this test. SCART loop-trough will be measured with the aid of an external video source. When entering the SCART loop-trough, the local display indicates:



Figure 15

On the TV screen, a colour bar (generated by nucleus VideoColDencOn) is visual and the internally generated pinknoise is audible. By pressing PLAY, the user confirms the test; pressing PAUSE will indicate the sound was inaudible or incorrect. Pressing NEXT will proceed to the next test; if the user presses NEXT without pressing PLAY or PAUSE first, the result of this test will be TRUE (sound ok). By pressing the NEXT button, there will be switched over to the external source, this must become now visible on the TV screen (using the SCART). The local display indicates:



Figure 16

The internally generated colour bar is still available on the CVBS and Y/C outputs. And the pinknoise-signal is still available on the cinch audio outputs. By pressing the PREV button, the internal generated colour bar becomes visual again.

The test can be left by pressing the NEXT key for more than one second.

2.3 SOUND 2 TEST

The second soundtest is performed by producing a sine sound (nucleus AudioSineOn). The signal can be stopped by pressing the STOP-key. The display shows the following message:

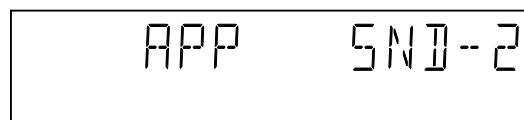

Figure 17

By pressing PLAY, the user confirms the test; pressing PAUSE will indicate that something went wrong. To proceed NEXT, press the STOP key first, press the NEXT key second and wait five seconds.

3 BASIC ENGINE

note) Basic engine means DVD mechanism.

3.1 VERSION NUMBER

In the basic engine tests, the version number of the Basic Engine will be shown first, as the following example:

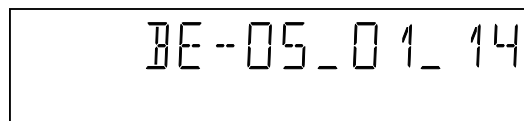

Figure 18

By pressing the NEXT key, the Basic Engine tests are started.

3.2 TRAY TEST

First, the tray is tested. The purpose of this test is also to give the user the opportunity to put a disc in the tray of the DVD player. Some tests on the Basic Engine require that a disc (e.g. DVD MPTD test disc) is present in the player. At the end of the Basic Engine tests, this tray test will be repeated solely to enable the user to remove the disc in the tray. The local display looks as follows:

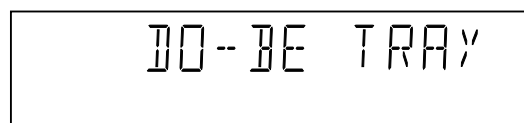

Figure 19

By pressing PLAY or PAUSE, the user can toggle the position of the tray. Note that this test will not contribute to

the test result of the Basic Engine. Pressing NEXT will proceed to the next test, after the tray has been closed (by the software) if it was open.

3.3 SLEDGE TEST(visual test)

The second Basic Engine test tests the sledge; the user can move the sledge as many times as desired by using PLAY (nucleus BeSledgeOut) and PAUSE (nucleus BeSledgeIn).

Pressing NEXT on the local keyboard proceeds to the next test.

Note that this test will not contribute to the test result of the Basic Engine. The local display looks as follows during the sledge test:

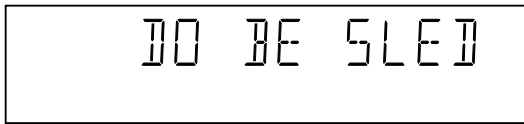

Figure 20

3.4 DISC MOTOR TEST(visual test)

The third Basic Engine test tests the disc motor (nucleus BeDiscMotorOn); the local display looks as follows:

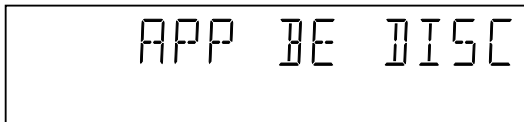

Figure 21

By pressing PLAY, the user confirms that the disc motor is running; pressing PAUSE indicates the disc motor does not work. Pressing NEXT proceeds to the next test, after a reset of the disc motor (nucleus BeDiscMotorOff). If the user presses NEXT before pressing PLAY or PAUSE, the result of this test will be TRUE (disc motor is running).

3.5 FOCUS TEST(visual test)

The fourth Basic Engine test tests the focussing; first focussing is turned on by calling nucleus BeFocusOn. The display looks as follows:

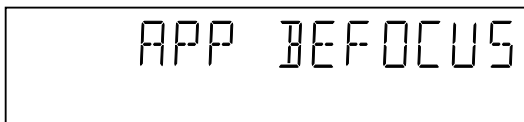

Figure 22

By pressing PLAY, the user confirms that the focussing was succesful; pressing PAUSE indicates a focussing failure.

Pressing NEXT proceeds to the next test after a reset of the focussing (nucleus BeFocusOff); if NEXT is pressed before PLAY or PAUSE, the result of this test will be TRUE (focus succesful).

3.6 RADIAL TEST(visual & listening test)

The fifth Basic Engine test tests the radial functionality (nucleus BeRadialOn); the local display looks as follows:

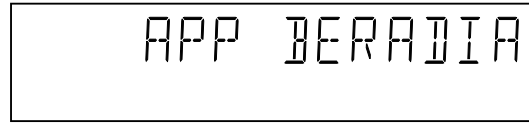

Figure 23

By pressing PLAY, the user confirms that the radial function worked; pressing PAUSE indicates the function does not work.

Pressing NEXT proceeds to the next test, after a reset of the radial (nucleus BeRadialOff). If the user presses NEXT before pressing PLAY or PAUSE, the result of this test will be TRUE (radial succesful).

3.7 JUMP TEST(listening test)

The sixth and last Basic Engine test tests the jumping by calling nuclei BeGroovesIn, BeGroovesMid and BeGroovesOut.

During this test, the local display looks as follows:

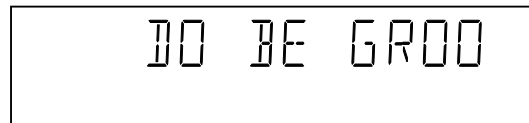

Figure 24

The user can switch between the three different types of groove settings by pressing PLAY (forward to next nucleus in the list In-Mid-Out) or PAUSE (backward in the list In-Mid-Out).

This is done in a cyclic manner; note that this test will not contribute to the test result of the Basic Engine. Pressing NEXT proceeds to the next test, after the disc motor has been shut off with a call to nucleus BeDiscMotorOff.

3.8 TRAY TEST

As a last action for the Basic Engine tests, the tray test is repeated. The local display looks as follows:

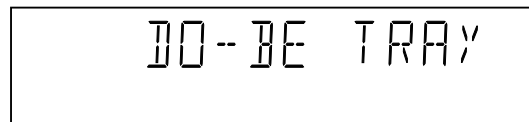

Figure 25

This test is meant to give the user the opportunity to remove the disc in the tray. The tray position can be toggled using the PLAY and PAUSE key. The tray will be closed (by the software, if it is open) before proceeding to the next test when the user presses the NEXT key.

DVD-S520/DV-S5450

3.9 ERROR LOG

Reading the error log and error bits information can be useful to determine any errors that occurred recently during normal operation of the DVD player. Reading the error log is done by nucleus LogReadErr. The display during the errorlog readout looks as follows :

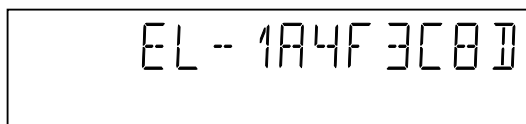

Figure 26

By pressing PLAY or PAUSE, the user can move forward or backward (respectively) through the logged error codes. The highlighted number indicates which errorcode is currently on display (in the example above, errorcode number 4 is displayed). If "0000" is displayed at all positions, the error log is empty. Display of the logged errors is done in a cyclic manner.

The errorcode with the lowest highlighted number is the

most recent. By pressing NEXT on the local keyboard, the user can proceed to the next test.

3.10 ERROR BITS

Reading the error bits is done by nucleus LogReadBits. The display during the errorbits readout looks as follows:

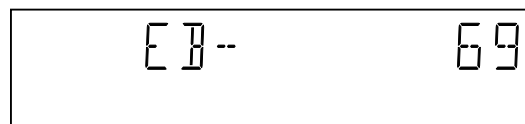

Figure 27

Only the set errorbits will be shown by their (decimal) number.

Refer to the appropriate documentation for the explanation of each bit number. If the display only shows "EB-0", no error bits were set. By pressing NEXT, the user can continue to the next test.

See table below:

Error log / bits table	Read ERROR LOG in player script	Read ERROR BITS in player script
Basic engine errors	Value:	Value:
Command to the Basic Engine not allowed in this state or unknown command	150101	8
Parameter(s) from the command to the Basic Engine is not valid	150102	7
Sledge could not be moved to the inner home position	150103	6
Focus failure	150104	5
Turntable motor speed could not be reached within timeout	150105	4
Radial servo could not get on track on the disc	150106	3
PLL could not lock in the accessing or tracking state	150107	2
Subcode or sector information could not be read	150108	1
requested subcode could not be found	150109	16
Tray could not be closed or opened completely	15010A	15
TOC could not be read within timeout	15010B	14
The requested seek on the disc could not be executed	15010C	13
A requested lead-in is not on the disc	15010D	12
A non existing burst cutting area is requested	15010E	11
S2b communication error	1501F0	10
S2b communication error	1501F1	9
S2b communication error	1501F3	24
S2b communication error	1501F4	23
S2b communication error	1501F5	22
Digital PWB errors		
Communication error with the Sti 5505	90000	32
Communication error with the Sti 5505	90001	31
Disply processor errors		
Communication error with the display processor	190000	40

4. LOOP TEST

At the start of the loop test, the display will show the result of the interactive player test:

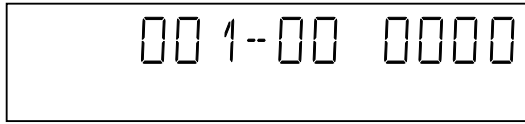

Figure 28

The left side of the display contains a 3-digit code, which can have a value between 000 and 111. These values are to be interpreted as follows:

Displayed Value	Indication for each module		
	Basic Engine	Mono PCB	Display PCB
000	ok	ok	ok
001	ok	ok	faulty
010	ok	faulty	ok
011	ok	faulty	faulty
100	faulty	ok	ok
101	faulty	ok	faulty
110	faulty	faulty	ok
111	faulty	faulty	faulty

Figure 29

The loop test will perform the same nuclei as the dealer test, but it will loop through the list of nuclei indefinitely. The display of the DVD player will display not only the three digits indicating correct/faulty modules and the last found error code (as mentioned, faults are detected as far as they can be within the scope of the diagnostic software), but also a loop counter indicating how many times the loop has been gone through.

Example:

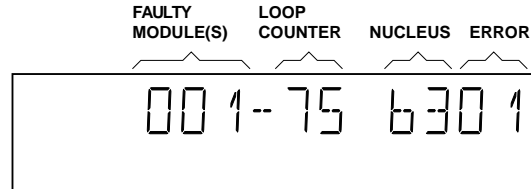

Figure 30

The number after the hyphen indicates the number of times the loop test has been performed; the 4 digits at the right side of the display show the last error that was found when running the loop test: the leftmost two digits of this code indicate which nucleus resulted in a fault; the rightmost two digits refer to the faultcode within that nucleus. For further explanation of this error code, see list of error codes below.

ERROR CODES LOOP TEST

ERROR CODE	NUCLEUS NUMBER	ERROR DESCRIPTION
0601	6	Calculated checksum of FLASH is not correct
0901	9	The DVD DRAM is faulty
1104	11	I2C bus busy before start
1102		NVRAM access time-out
1103		No NVRAM Acknowledge
1104		NVRAM reply time-out
1201	12	I2C bus busy
1202		I2C bus not working
1203		Slave controller not responding
1204		Slave response is not correct
1301	13	Parity error from basic engine to serial
1302		Parity error from serial to basic engine
1303		No communication between serial and basic engine
1304		Communication time-out error
1601	16	The SDRAM is faulty
5201	52	I2C bus busy
5202		Error sending I2C command to COLOR SETUP IC
5203		Colour setup IC not responding
5204		Colour setup IC response is not correct
5401	54	I2C bus busy
5402		Error sending I2C command to SCART SWITCH IC
5403		SCART Switch is not responding
5403		SCART Switch response is not correct

Figure 31

5. Servicing DVD module and MONO board

5.1 Reset of Virgin Mode

After the player has been powered up for test by the dealer, it would have gone through the Virgin Mode. It is possible to reset the settings made during that mode before the delivery of player to the customer. This can be done as shown in the following diagram:

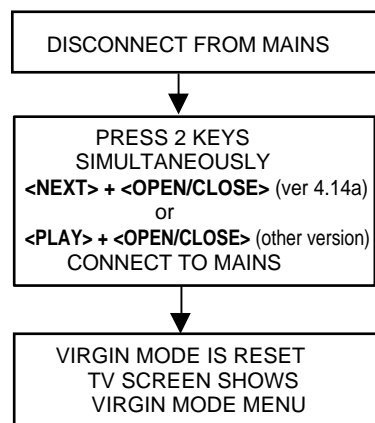

Figure 32

5.2 Trade Mode

When the player is in Trade Mode, the player cannot be controlled by means of the front key buttons, but only by means of the remote control.

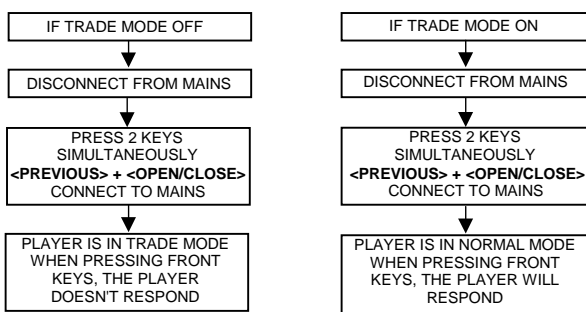

Figure 33

TEST INSTRUCTIONS

1 AV Board

These test instructions can be used for all versions of the AV board which has the following outputs:

- Audio L/R
- 5.1 Audio output
- Subwoofer output
- Optical / Coaxial digital output
- CVBS
- Y/G_vid,U/B_vid,V/R_vid output
- S-video
- Scart output

1.1 General

- All the waveforms measurement carried out in these test instruction will be base on the testpoint indicated in the AV board schematic diagram in the Service manual.
- Impedance of the measuring-equipment should be > 1MΩ
- Most of the tests can be done using either the Diagnostic software "Player script" which can be found in the chapter "Diagnostic Software description and troubleshooting" or the Menu interface using the Service PC with a terminal emulation program (e.g. Window Hyperterminal) where it is possible to control the execution of the Diagnostic Nuclei
- Setup for the measurement will be done in set level with all modules connected as shown in the Wiring Block diagram.

1.2 General Start-Up Measurement

Supply Check:

Before starting the measurement,ensure that all power supply are connected to the AV board.

Pin nbr	Supply
1010-9	-5V (-Vcc)
1010-10	+5V
1010-11	+5V

The supply currents can be measured using a Tektronics AM503B current probe or equivalent.

Supply	Power consumption (AVG)
+5VA	+5V ± 3% I = 200mA
+5Vvid	+5V ± 3% I = 200mA
-5V	-5V ± 3% I = 200mA

Clock Check

Ensure the present of the clock to the DAC

Clock Name	Testpoint	Frequency
PCM_CLK	TP10	11.2896MHz ± 0.02% tolerance

Audio Mute Check

Measure the Audio mute voltage input at pin 12 of connector 1010

Status	Value
AudioMuteOn	4.7V ± 10%
AudioMuteOff	-8V ± 10%

To toggle between ON and OFF, use the following commands:

Ref.#	Command Name	Remarks
19a	AudioMuteOn	Audio Mute On
19b	AudioMuteOff	Audio Mute Off

1.3 Audio DAC And Amplifier

Ensure that the Audio mute signal is OFF

To check the DAC and buffer amplifier, send the following commands:

Ref.#	Command Name	Remarks	Audio output
21a	AudioSineOn	Audio Sine signal ON	Sine, 1Khz on stereo
----	Press stop button	Audio Sine signal OFF	No waveform
20a	AudioPinkNoise On	Audio Pinknoise ON	Pink Noise on 6 channels
20b	AudioPinkNoise Off	Audio Pinknoise OFF	No waveform

The audio signal (sine or pink noise) will also be present on the digital output (SPDIF). This can be checked by connecting digital signal to an amplifier with digital input. Check the I2S and audio signal at the following testpoints:

Name	Testpoint
LRCLK	TP8
SCLK	TP9
PCM_CLK	P10
PCM_OUT0	TP7
PCM_OUT1	TP27
PCM_OUT2	TP28
SPDIF	TP11
Front L/R out-Audio cinch	TP13
H/P L/R out	TP20
Analog out -Audio cinch	TP25

All waveforms can be refer to the waveform diagram in the chapter "Diagnostic software description and troubleshooting".

1.4 Video Output And Buffer Amplifier

Check DC output-level at all video cinch output : 1.0V DC 10% Generate a color bar using the following software commands:

Ref.#	Command Name	Remarks
23a	VideoColDencOn	Colour DENC ON
61a	VideoColOutRGB	RGB Colourbar
61b	VideoColOutYUV	YUV Colourbar
23b	VideoColDencOff	Colourbar DENC OFF

Check the video outputs at the following testpoints:

Name	Testpoint
B_VID	TP1
G_VID	TP2
R_VID	TP3
CVBS out	TP14
S-Video-C out	TP15
S-Video-Y out	TP16
Y out	TP17
U out	TP18
V out	TP19

All waveforms can be refer to the waveform diagram in the chapter "Diagnostic Software description and troubleshooting".

1.5 Play And 16/9 Detection

Check DC voltage at S-Video-chroma output (pin 4) with a 6K8 ohm load and Scart connector (pin 8) and change the 0/6/12 input (1010-8) using the following commands:

Ref.#	Command Name	Remarks	Chroma output
25a	VideoScartLo	Sends out 0V ±0.5V	<0.1V
25b	VideoScartMi	Sends out 6V ±10%	2.0V ± 10% with load 5.0V ± 10% without load
25c	VideoScartHi	Sends out 12V ±10%	<0.1V

1.6 Kill Circuit

To check the functionality of the Kill circuitry, the audio outputs has to be present by the following command:

Ref.#	Command Name	Remarks	Audio output
21a	AudioPinkNoise On	Audio Pinknoise ON	Pink Noise on 6 channels

Check the audio outputs at the audio cinch of the AV board :PinkNoise

Activate the Kill circuit by using the following command:

Ref.#	Command Name	Remarks
19a	AudioMuteOn	Audio Mute On

Check the audio outputs at the audio cinch of the AV board : No waveform

Switch off the kill circuit by using the following command:

Ref.#	Command Name	Remarks
19b	AudioMuteOff	Audio Mute Off

Check the audio outputs at the audio cinch of the AV board :PinkNoise

DVD-S520/DV-S5450

2. Display board

2.1 Introduction

These test instructions are written for all versions of the display PCB.

The contents of the PCB can be split up into next blocks:

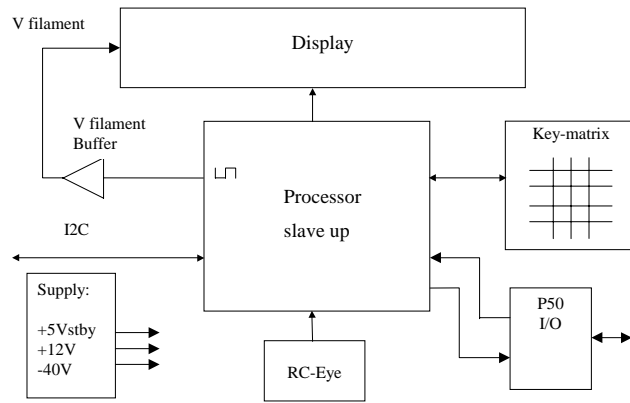

Figure 1

2.2 Functionality description:

The essential component of the display PCB is the μP (slave).

This slave works on an 8MHz resonator and has a reset circuit that is triggered by the +5Vstby. After the reset pulse, the standby control line will release the reset of the host μP . This host μP will then initialize the slave. In addition, when going to stand-by, the slave will put the host μP in reset. When the slave receives the right IR or key code to leave the standby mode, the reset of the host μP will be released.

Other slave functions are:

- Square signal generator to generate the filament voltage, which is required for an AC FTD.
- Generating the grid and segment scanning for the FTD.
- Generating a scanning grid for the keys (separated from display scanning).
- Having inputs for RC (RC5 and RC6) and P50 (P50 controller is built in).

2.3 Reset

Check next reset timing with an oscilloscope at pin 10 of the microprocessor.

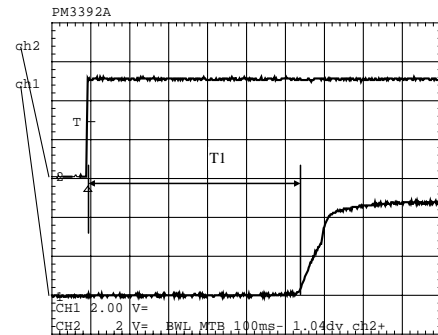

Figure 2

Timing: $400\text{msec} < T1 > 700\text{msec}$.

CH1: +5Vstby voltage at power on.

CH2: Voltage at pin 10.

2.4 Display steering

Check next timing and level for all grid-lines (G1 r G14).

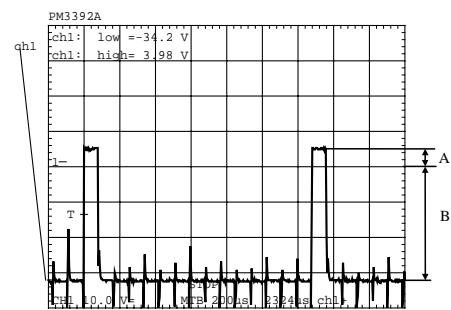

Figure 3

1. Check level A: +4V5 +/-10% for grid lines 1 => 11
2. Check level A: +4V0 +/-10% for grid lines 12 => 14
3. Check level B: -33V +/-10%
4. Check timing and levels of segment-lines P1 => P10:

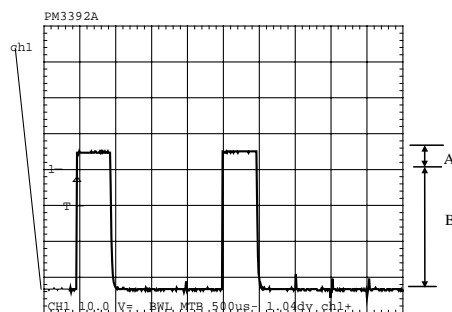

Figure 4

Level A: +4V5 +/-10%

Level B: -33V +/-10%

The data on these segment lines depend on the characters that are displayed.

The characters can be set by sending I2C commands to the display.

See the Slave URS how to send a display command.

2.5 Key-matrix

Connect a extra 10kpull-up resistor to pin 36 en 37 of the μ P and check next matrix scanning at these pins.

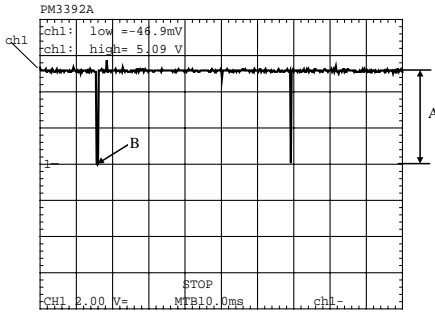

Figure 5

Level A: 5.0V +/-7%

Level B: 0V +/-200mV

Check matrix scanning from pin 26 until 33 of the μ P.

The results should be the same as the diagram above.

2.6 I.R. receiver

Check at pin 23 of the μ P if this line switches from low (< 0.3V) to high (> 4.5V), while pressing a key on a Philips RC5 or RC6 remote control.

2.7 Karaoke interface

The karaoke interface (4 lines) is a single direction communication.

This means that it consists of four μ P output lines.

The interface can be checked by setting or resetting these output-ports via the I2C bus.

Send next command via the I2C bus:

- Address : 0x70
- Command byte : 0x24
- Data byte : xxxxabcd
- Where : a = Karaoke reset.
- : b = Karaoke data.
- : c = Karaoke clock.
- : d = Karaoke strobe.

2.8 P50 interface

P50 is a bi-directional serial interface, which is used for communication between video equipment. For European sets, this communication goes via pin 10 of the scart-bus. In other regions, it can be a cinch bus at the back of the set.

1. Keep the μ P in reset by short-circuiting emitter and collector of transistor 7108, via resistor 3100 and 3104 transistor 7101 is switched on.
2. Check the voltage at the P50 output connector 1118-5: < 200mV.

When the reset is released the μ P output-pin becomes low and transistor 7101 is switched off.

1. Check the voltage at the P50 output connector 1118-5: 4.9V +/-5%.
2. Check also the μ P P50 input (μ P pin 20): 5V +/-5%.
3. Connect the P50 line (connector 1118-5) to ground.
4. Check again the μ P P50 input (μ P pin 20): <0.3V.

■ TROUBLESHOOTING

1. TROUBLESHOOTING AV BOARD

Testing of AV board can be done using diagnostic software "PLAYER SCRIPT".

MONO board is used to generate a sound with the sound tests SND-1 and SND-2 or a VIDEO signal with the picture PIC-1. See description in the chapter of "DIAGNOSTIC SOFTWARE: SCRIPT INTERFACES".

AUDIO PART OF AV BOARD (ANALOG)

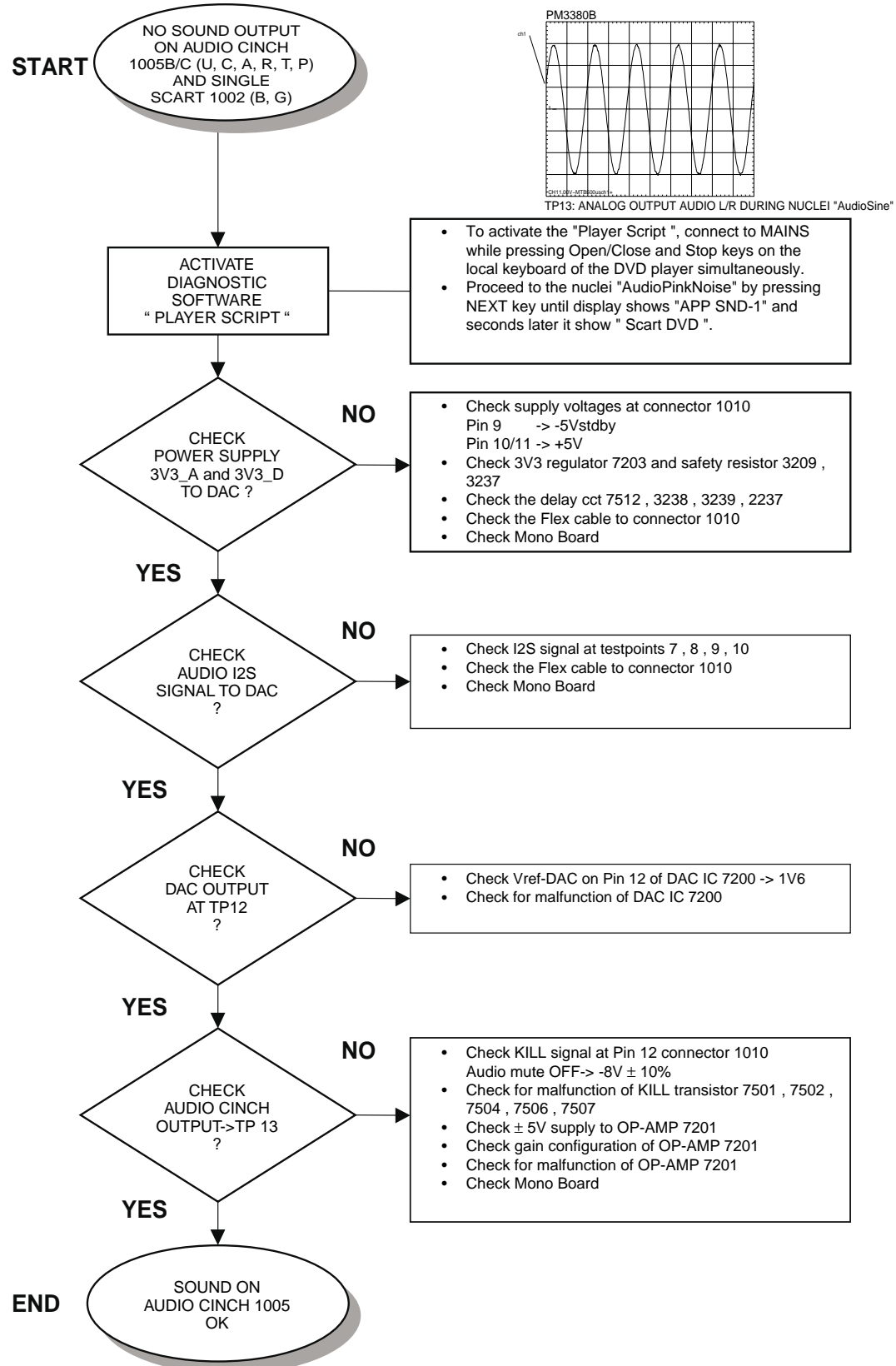

AUDIO WAVEFORM MEASUREMENT

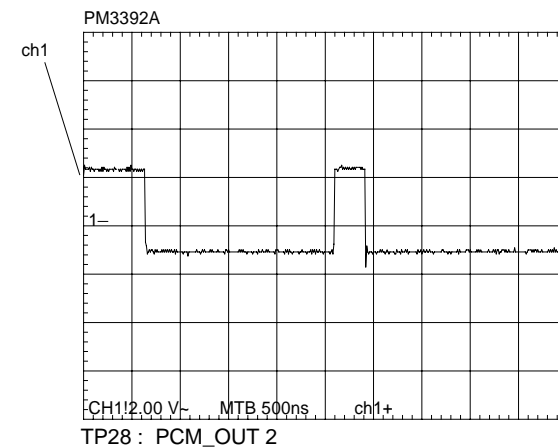
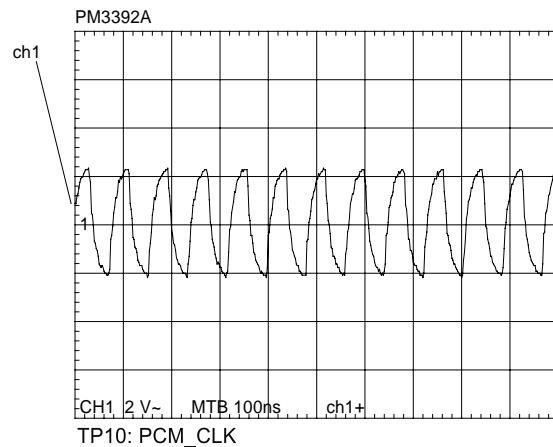
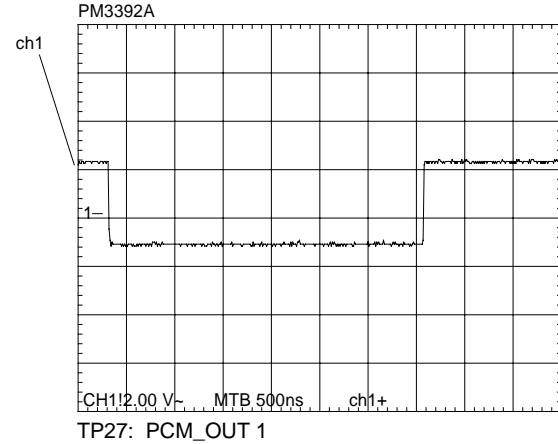
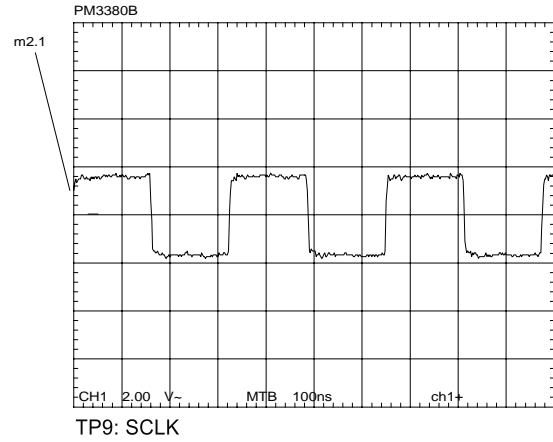
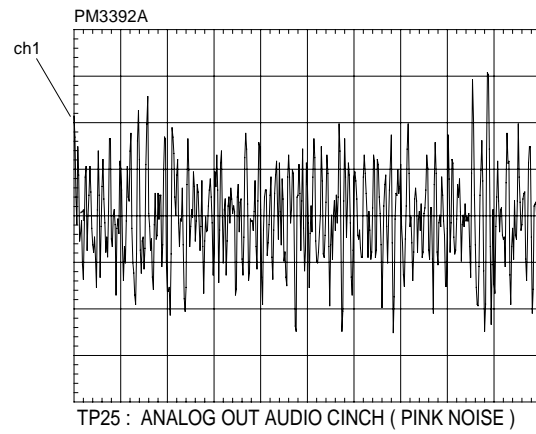
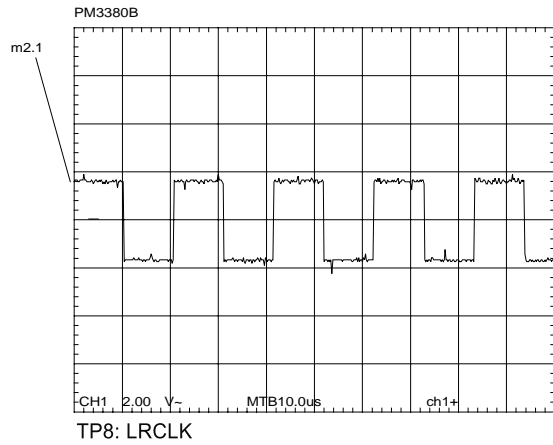
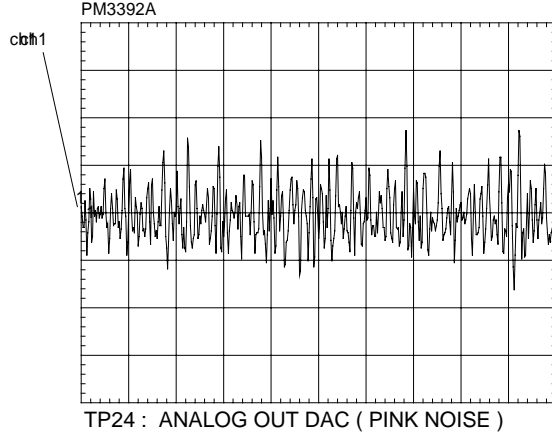
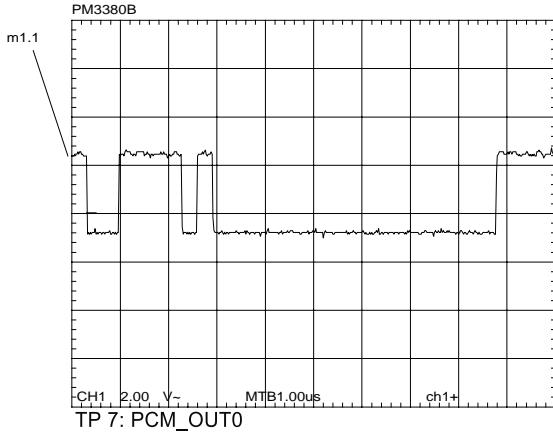

DVD-S520/DV-S5450

AUDIO PART OF AV BOARD (DIGITAL)

START

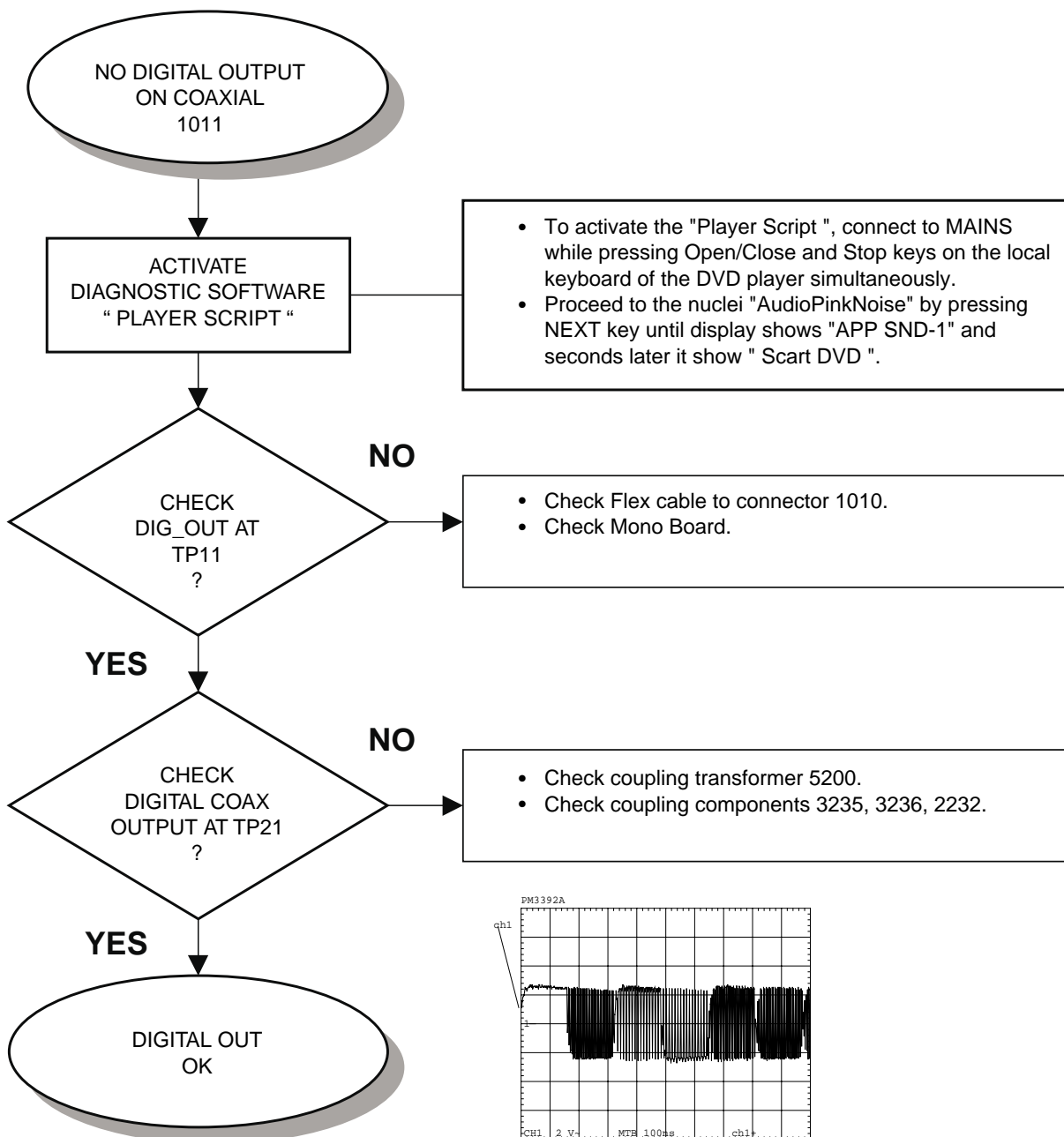

- To activate the "Player Script ", connect to MAINS while pressing Open/Close and Stop keys on the local keyboard of the DVD player simultaneously.
- Proceed to the nuclei "AudioPinkNoise" by pressing NEXT key until display shows "APP SND-1" and seconds later it show " Scart DVD " .

- Check Flex cable to connector 1010.
- Check Mono Board.

- Check coupling transformer 5200.
- Check coupling components 3235, 3236, 2232.

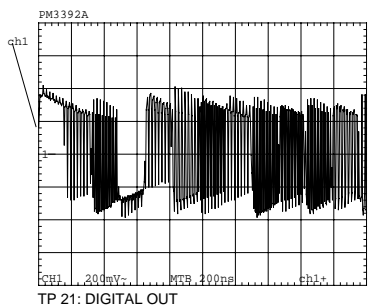
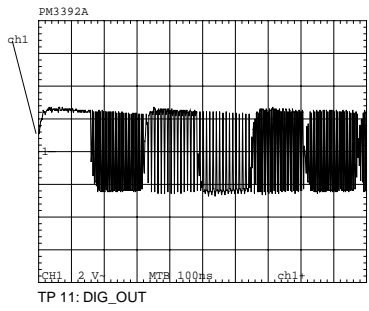

DVD-S520/DV-S5450

VIDEO PART OF AV BOARD (U, C, A, R, T, P)

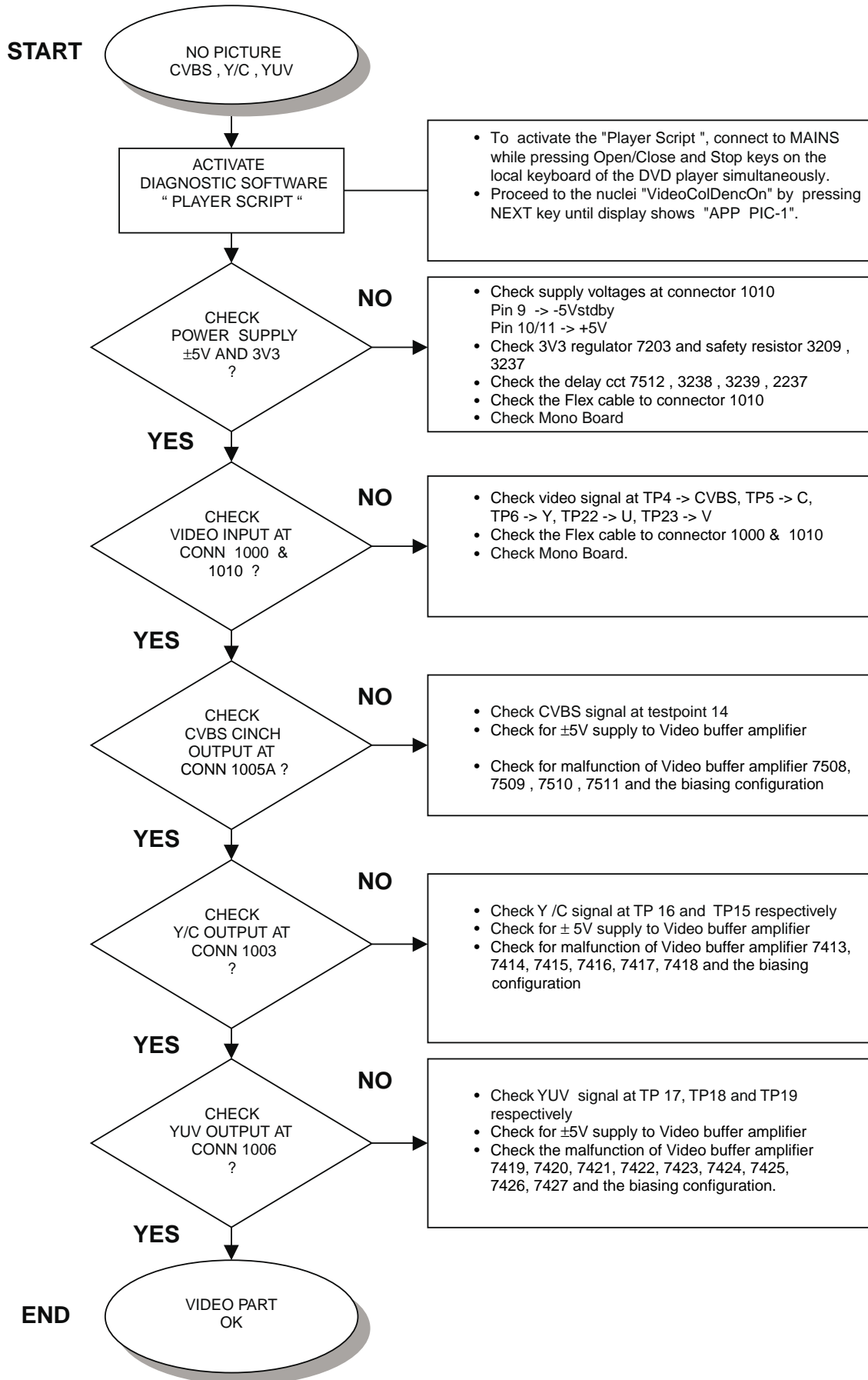

DVD-S520/DV-S5450

VIDEO PART OF AV BOARD (G, B)

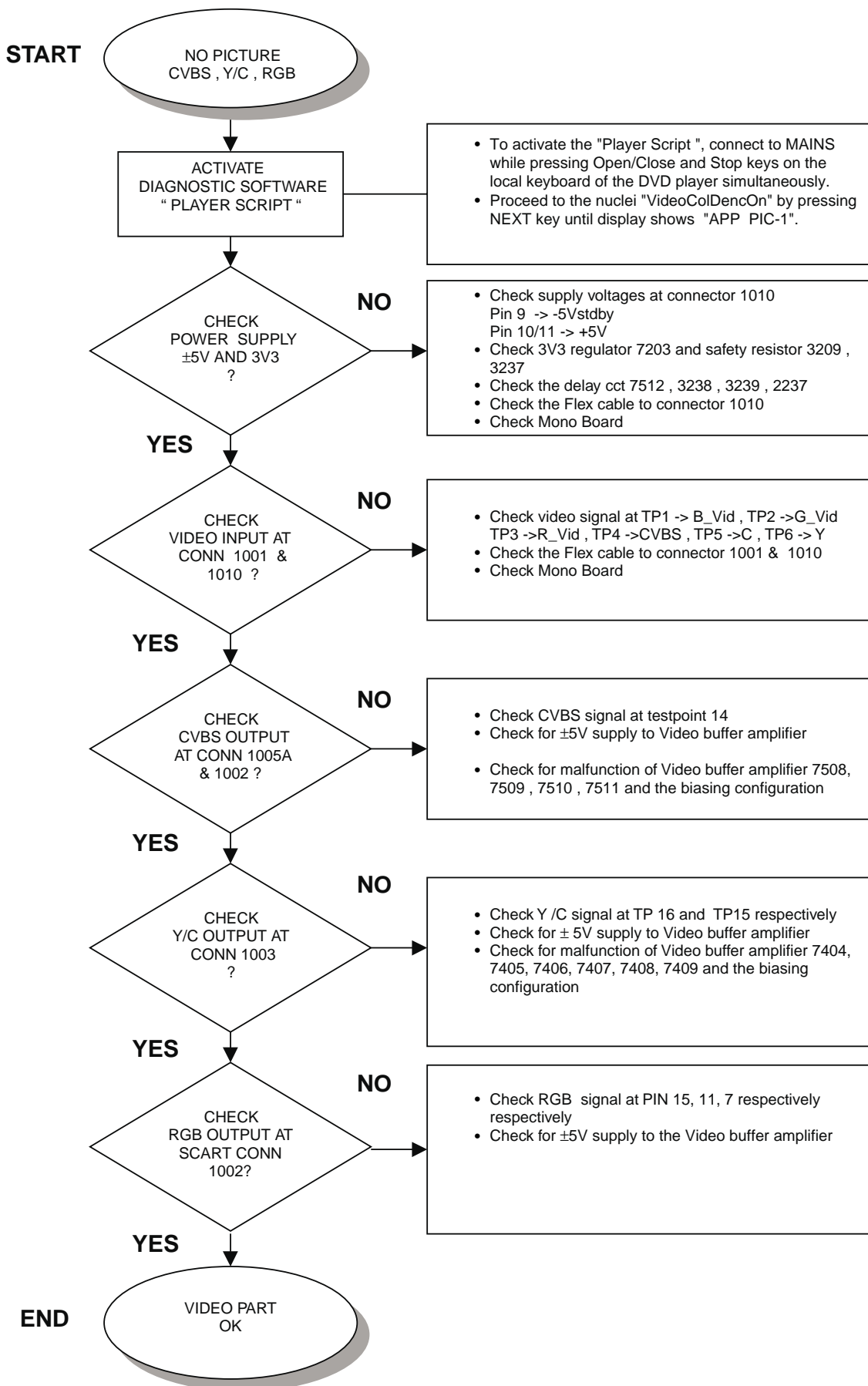

DVD-S520/DV-S5450

VIDEO WAVEFORM MEASUREMENT

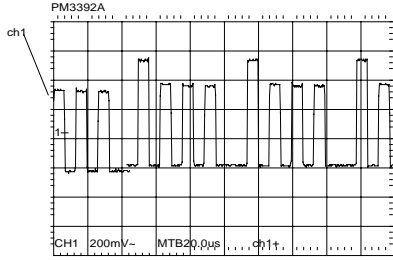

TP 1 : VIDEO B

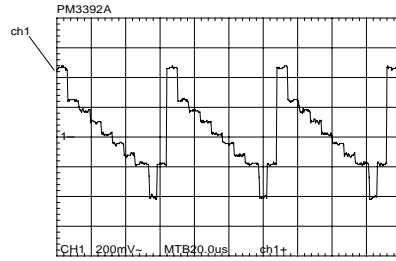

TP 6 : Y_ENC

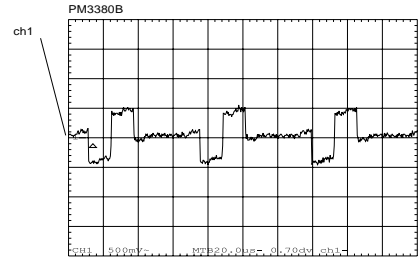

TP 19 : V_VID OUT

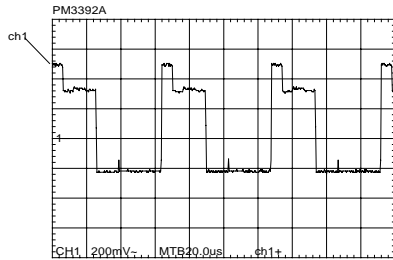

TP 2 : VIDEO G

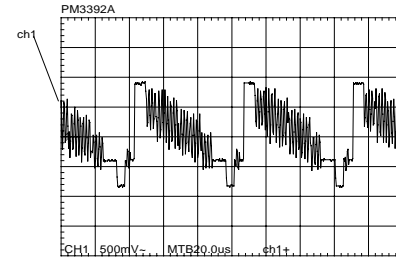

TP 14 : CVBS_OUT

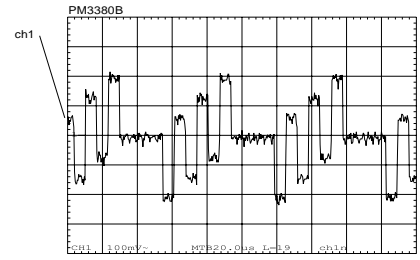

TP 22 : U_VID

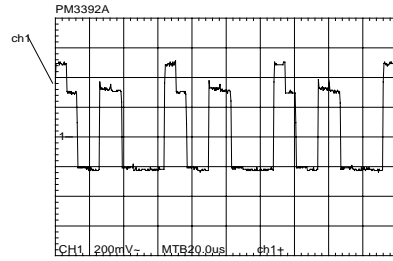

TP 3 : VIDEO R

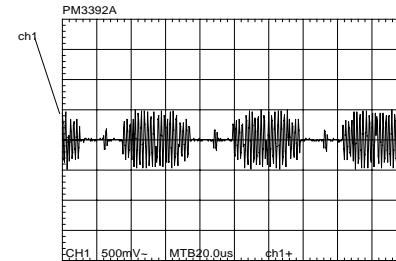

TP 15 : C_OUT

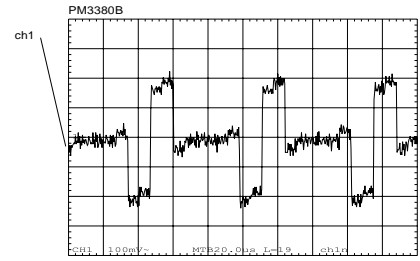

TP 23 : V_VID

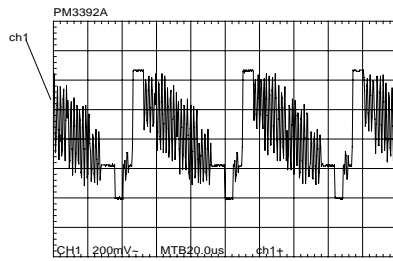

TP 4 : CVBS

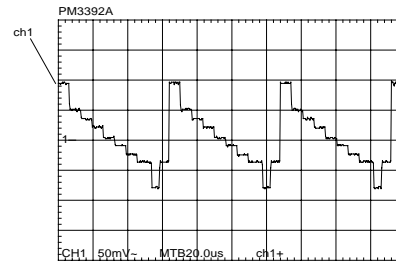

TP 16 /17 : Y_OUT

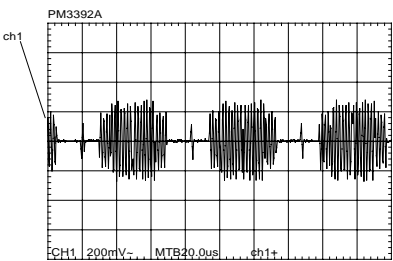

TP 5 : C_ENC

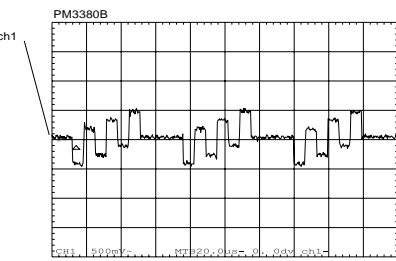

TP 18 : U_VID OUT

DVD-S520/DV-S5450

2. TROUBLESHOOTING POWER SUPPLY UNIT VFM (B, G)

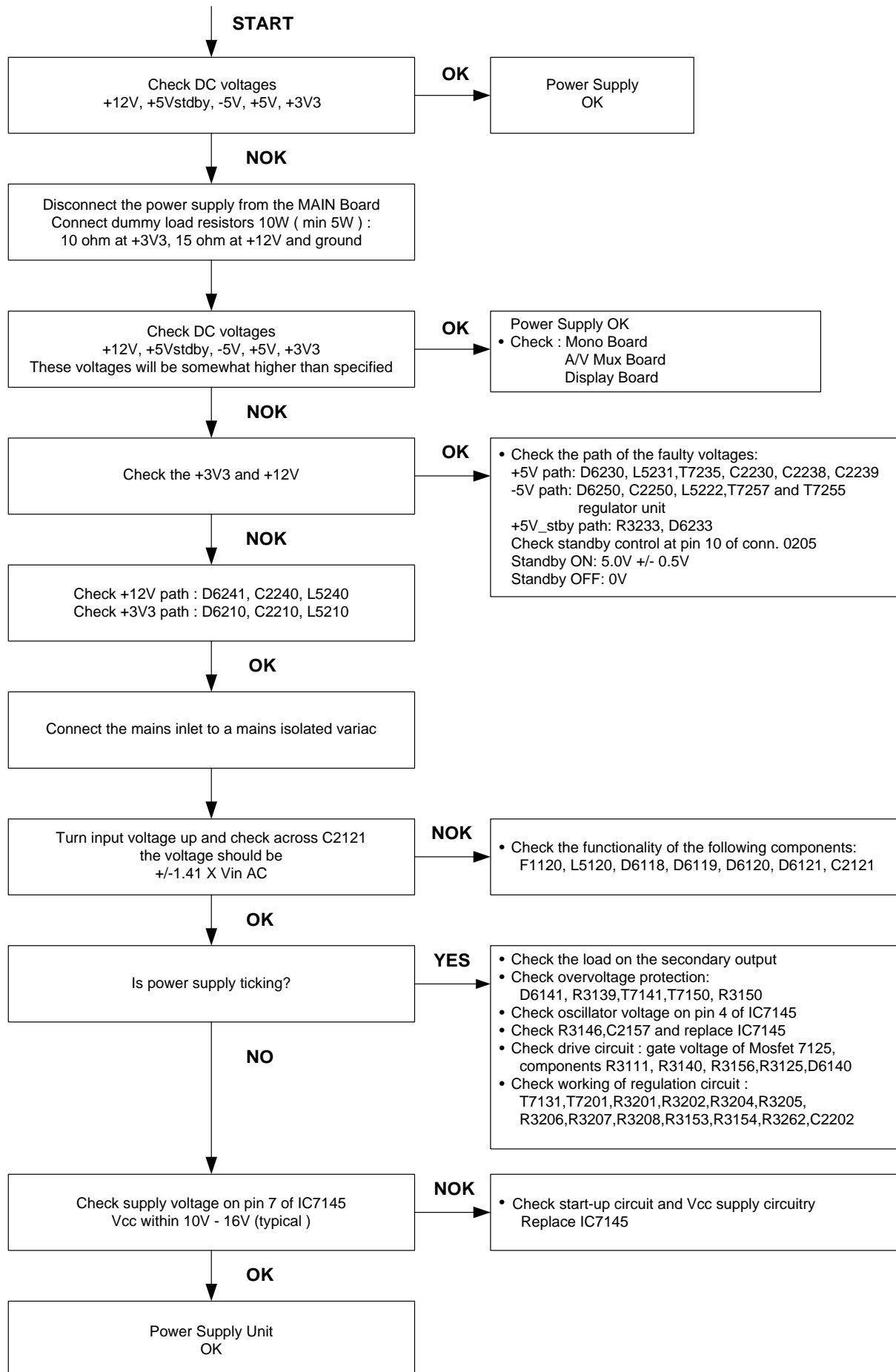

■ TECHNICAL SPECIFICATIONS DVD MODULE

1.1 Connections

1.1.1 Connector 1600: Supply input connector.

1. +3V3stby
2. +3V3stby
3. +5V
4. +5Vstby
5. +6Vstby
6. GND
7. GND
8. GND
9. -8Vstby (-5V,on new PSU)
10. Standby control line
11. +12Vstby
12. GND

1.1.2 Connector 1603: A/V 1 connector.

1. P50
2. Blue Video / U
3. Green Video / Y
4. GND
5. Red Video /V
6. CVBS
7. GND
8. Slow blanking scart
9. -8Vstby (-5V,on new PSU)
10. +5V
11. +5V
12. Audio mute
13. GND
14. I2S data0 out
15. I2S wordselect
16. I2S bitclock
17. GND
18. I2S systemclock
19. Center_on
20. Kar_bypass
21. SPDIF out
22. GND

1.1.3 Connector 1604: A/V 2 connector.

1. GND
2. Hor. sync.
3. GND
4. I2S data 2 out
5. GND
6. I2S data 1 out
7. -8Vstby (-5V,on new PSU)
8. I2C clock
9. +12Vstby
10. I2C data
11. +6Vstby
12. +3V3
13. GND
14. C video
15. GND
16. Y video

1.1.4 Connector 1501: I2C interface connector.

1. I2C clock
2. GND
3. I2C data
4. Standby control line
5. P50

1.1.5 Connector 1602: Service connector.

1. TXD

2. Service activation
3. RXD
4. Reserved for RTS
5. 5: GND
6. CTS
7. +5V

1.1.6 Connector 1507: Karaoke connector.

1. GND
2. ADC_SCLK
3. ADC_LRCLK
4. ADC_DATA
5. ADC_PCMCLK
6. +5V
7. -8V stby (-5V,on new PSU)
8. N/C

1.2 Signal specifications

This the specification of all signals as described under "Connections"

H = +5V ±0.5V

h = 3V3 ±0.3V

L = 0V ±0.5V

l = 0V ±0.3V

Stby

Standby control line

P50

Slow blanking scart

Audio mute

I2S data0 out

I2S wordselect / I2Sbitclock

I2S systemclock

- : If the set supports a "standby" function, all supply voltages marked with "stby"
- : have to stay on during standby.
- : H Standby mode
- : L On mode.
- : Connection between front and A/V board, and can be used as P50 signal line.
- : The signal is not connected to the module electronics.
- : This signal switches between
- : 0V (220output impedance)
- : 12Vstby/2 (455Ω output impedance)
- : 12vstby (690Ω output impedance)
- : Can be used for audio mute transistors during stop or power On/ Off.
- : Mute on : +5Vstby
- : Mute off: -8Vstby via a 10kresistor.
- : I2S front data output.
- : Level h / l
- : I2S timing signals
- : Level h / l
- : 256xFS audio systemclock.
- : Level H / L

Kar_bypass	: Bypasses the karaoke chip on the A/V board. : Bypass activeH : Bypass offL
Center_on	: Switches the center audio to the scart output. : Center to scarth : L/R to scartl
Karaoke	: I2S inpath / I : PCMCLK outputH / I
SPDIF out	: Digital audio output levelH / L
Hor. Sync	: Video Horizontal synchronisation Levelh / I
I2S data1 out	: I2S surround data output. : Level: h / l.
I2S data2 out	: I2S center/sub data output. : Level h / l.
I2C clock / I2C data	: I2C databus : Level: h / I
TXD / RXD / RTS / CTS	: Service UART to be connected direct to PC serial input. : Output levelsH / L : Input levelsRS232 compliant
Service activation	: Signal openNormal module start-up : Signal tied to GND Module start-up in service mode.
Vreserved	: Is now configured for +6V stby & is only an inter-connection via the mono-board and not used by any IC's on the module. However, there's an on board 47uF/16V elco and a 100nF/16V X7R connected to this pin.

1.3 Performance:

1.3.1 Digital output

CDDA/LPCM	: according IEC60958
MPEG1 is converted to LPCM	:
MPEG2, AC3 audio.MP3	: according IEC1937
DTS.	: according IEC61937 amendment 1. : Digital output level is 0V / 5V with GND as reference. To meet the standards a decouple circuit is necessary.

1.3.2 I2S output

Accuracy	: Up to 24bit.
Sample rate	: 44.1kHz / 48kHz / 96KHz
Standard	: Philips I2S output
Number of I2S outputs	: 3 (6 channel: Front / Surround / Center-Bass)
Deemphasis	: Already processed in module.
Audio source streams	: CDDA / MPEG1 / LPCM / MPEG2 / AC3 : No DTS decoding.
Audio processing	: Dolby Pro Logic (multichannel downmix on front output) : 3D sound.

1.3.3 Analog output

The module has no analog audio output.	: The analog audio specification will be determined by the external DAC circuit.
--	--

1.3.4 Video.

Standards	: The video output standard will follow the source material. : The OSD standard is switchable between PAL or NTSC.
Outputs	: The module has 6 analog outputs (4formats): Y/C ; CVBS ; RGB / YUV
Specification.	: The output complies fully according PQR3 IMS except : Output load > 1k(to GND / Cap. load < 47pF. : Level 0.5Vpp with 100% white : Sync level 300mV (PAL), 286mV (NTSC) from blanking level : Some specification points are significantly better than PQR3 : SNR on all video outputs is better than 60dB. : Video bandwidth > 5MHz (±3dB)

■ LIST OF ABBREVIATIONS

B	Buffered Video input Blue from DVD monoboard	Y_ENC	Buffered Luma input from DVD monoboard
BC_AUX	Blue or Chroma input from AUX-scart	YCVBSIN_AUX	Luma or CVBS input from AUX-scart
BC_TV	Blue or Chroma output to TV-scart	YCVBSIN_TV	Luma or CVBS input from TV-scart
C_ENC	Buffered Chroma input from DVD monoboard	YCVBSOUT_AUX	Luma or CVBS output to AUX-scart
CVBS	Buffered Composite video input from DVD monoboard	YCVBSOUT_TV	Luma or CVBS output to TV-scart
DC_OFF	Control signal to switch off -5Vstby and +12Vstby during standby	0/6/12	Scart switch control signal A/V board. 0V : loop through (AUX to TV), 6V : play 16:9 format, 12V : play 4:3 format
DIG_OUT	Digital out		
FBIN_AUX	Fast blanking input from AUX-scart		
FBOUT_TV	Fast blanking output to TV-scart		
G	Buffered Video input Green from DVD monoboard		
GIN_AUX	Video input Green from AUX-scart		
GOUT_TV	Video output Green to TV-scart		
HP_L	Audio output left to headphone and audio scart switch TEA6420		
HP_R	Audio output right to headphone and audio scart switch TEA6420		
KILL	Kill control signal for audio outputs and for soft mute of DAC		
LIN_AUX	Audio input left from AUX-scart		
LIN_TV	Audio input left from TV-scart		
LOUT_AUX	Audio output left to AUX-scart		
LOUT_TV	Audio output left to TV-scart		
LRCLK	Left/Right clock		
PCM_CLK	Audio system clock for DAC		
PCM_OUT0	Audio serial output data		
R	Buffered Video input Red from DVD monoboard		
RCIN_TV	Red or Chroma input from TV-scart		
RCOUT_TV	Red or Chroma output to TV-scart		
RIN_AUX	Audio input right from AUX-scart		
RIN_TV	Audio input right from TV-scart		
ROUT_AUX	Audio output right to AUX-scart		
ROUT_TV	Audio output right to TV-scart		
SCL	I2C bus clock		
SCLK	Audio serial bit clock		
SDA	I2C bus data		
SELECT	Control signal for video scart switches; high = TV ,low = AUX		
SELECT_HIGH	Control signal for switching fast blanking and slow blanking signals; high = TV ,low = AUX		
SLB_AUX	Slow blanking control signal from AUX-scart		
SLB_TV	Slow blanking control signal to TV-scart		
STANDBY	Control signal from STI5505 used to swith off -5Vstby and +12Vstby during standby.		
STEREO_L	Audio cinch output left		
STEREO_R	Audio cinch output right		

IC DESCRIPTIONS

TZA1033

DVDALAS2plus Advanced Analog DVD Signal Processor and Laser Supply

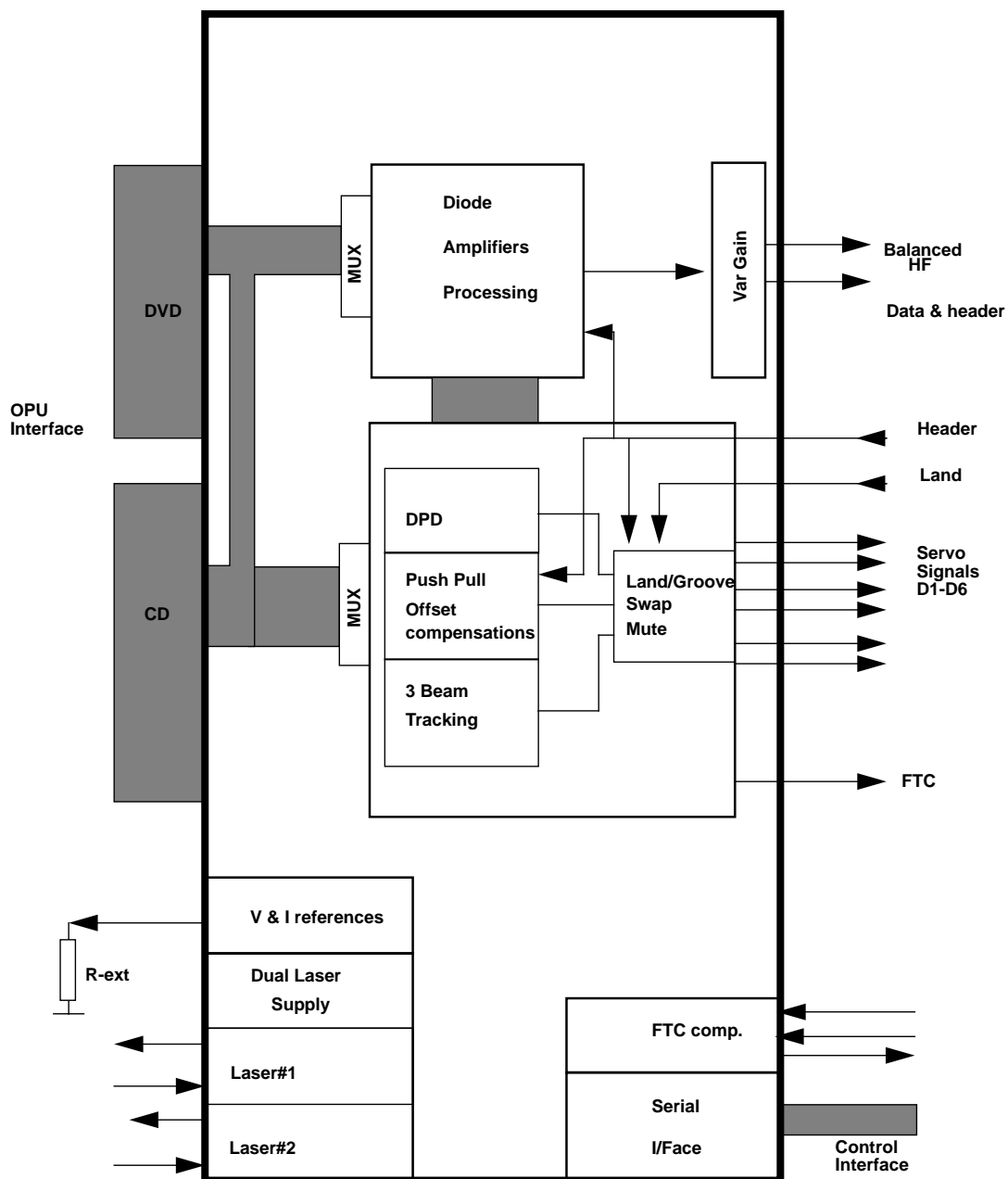

DVD-S520/DV-S5450

TZA1033

DVDALAS2plus Advanced Analog DVD Signal Processor and Laser Supply

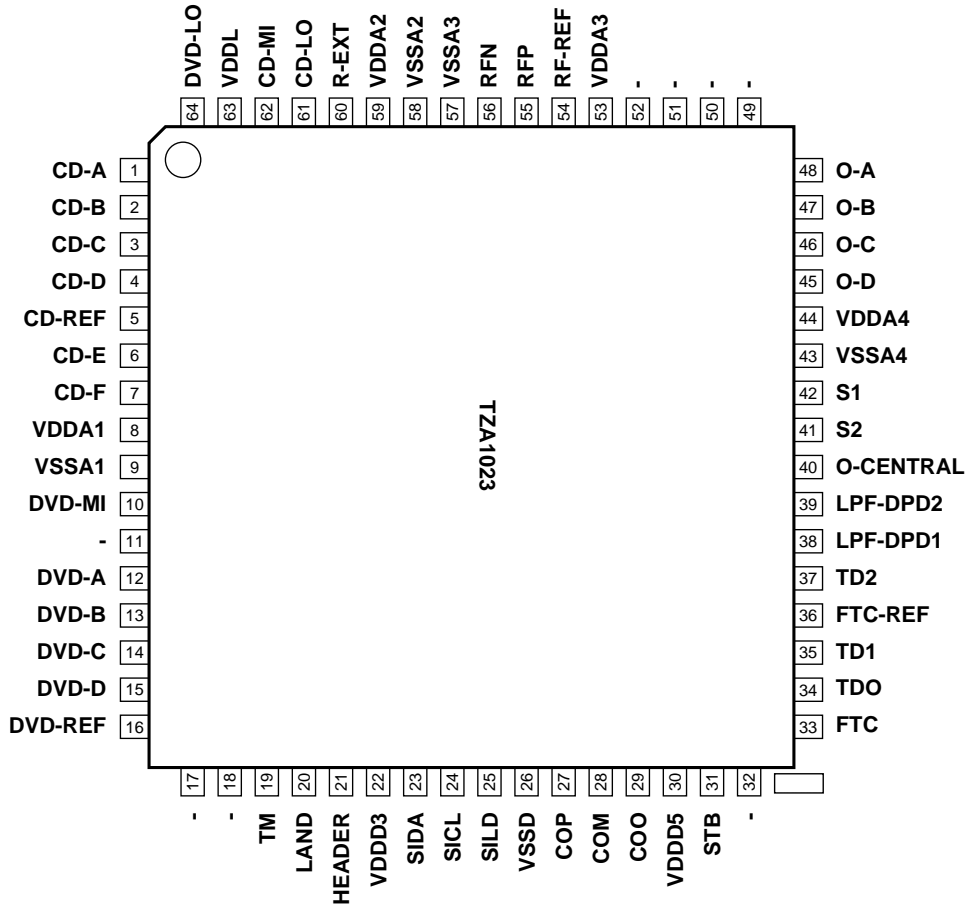

Pin description

Name	Pin	Description
CD-A	1	CD pick up input A
CD-B	2	CD pick up input B
CD-C	3	CD pick up input C
CD-D	4	CD pick up input D
CD-REF	5	CD pick up reference voltage
CD-E	6	CD pick up input E
CD-F	7	CD pick up input F
DVD-A	12	DVD pick up input A
DVD-B	13	DVD pick up input B
DVD-C	14	DVD pick up input C
DVD-D	15	DVD pick up input D
DVD-ref	16	DVD pick up reference voltage
O-A	48	Servo current output for Focus-A
O-B	47	Servo current output for Focus-B
O-C	46	Servo current output for Focus-C
O-D	45	Servo current output for Focus-D

DVD-S520/DV-S5450

TZA1033**DVDALAS2plus Advanced Analog DVD Signal Processor and Laser Supply**

Name	Pin	Description
O-central	40	Test pin for offset cancelation
TD2	37	Internally connected
FTC-ref	36	Servo output voltage reference input
S1	42	Servo current output for radial tracking
S2	41	Servo current output for radial tracking
TD1	35	Internally connected
FTC	33	Fast track count voltage output
RFP	55	pos. RF output signal
RFN	56	neg. RF output signal
RF-REF	54	DC Reference signal input RF
LPF-DPD1	38	DPD Low pass bandwidth capacitor, channel pos
LPF-DPD2	39	DPD Low pass bandwidth capacitor, channel neg
Land	20	Land/groove toggle input
HEADER	21	Header detector window input
CD-MI	62	CD laser monitor input
DVD-MI	10	DVD laser monitor input
CD-LO	61	CD laser output
DVD-LO	64	DVD laser output
COP	27	Positive input FTC comparator
COM	28	Inverting input FTC comparator
COO	29	FTC comparator output
SIDA	23	Serial host interface data input
SICL	24	Serial host interface clock input
SILD	25	Serial host interface load
VDDA1	8	Analog Supply voltage 1 (RF input)
VDDA2	59	Analog Supply voltage 2 (RF internal)
VDDA3	53	Analog Supply voltage 3 (RF output stage)
VDDA4	44	Analog Supply voltage 4 (Servo)
VDDD5	30	Digital Supply voltage (5V dig core)
VDDD3	22	Digital Supply voltage (3V I/O pads and FTC comp.)
VDDL	63	Supply voltage for laser
VSSA1	9	Analog Ground 1
VSSA2	58	Analog Ground 2
VSSA3	57	Analog Ground 3
VSSA4	43	Analog Ground 4
VSSD	26	Digital ground
R-EXT	60	Reference current input (Connect 12k1 to VSSA4)
STB	31	Standby input
TM	19	Test mode input
TDO	34	Test data out

BA6856FP

3 Phase motor driver for DVD players

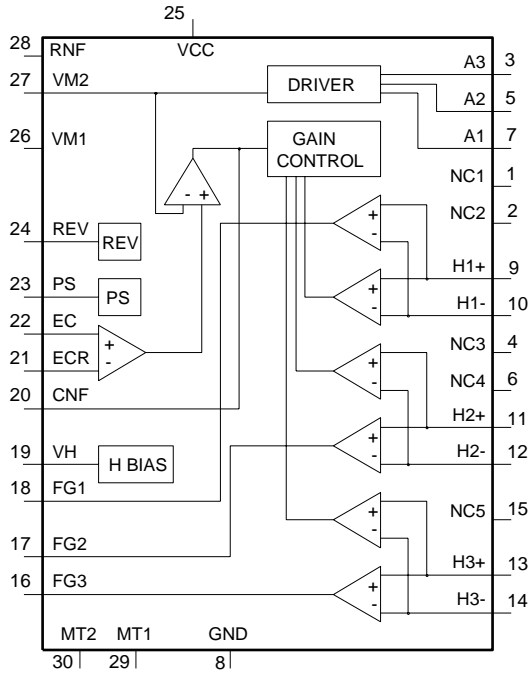

Terminal lay-out

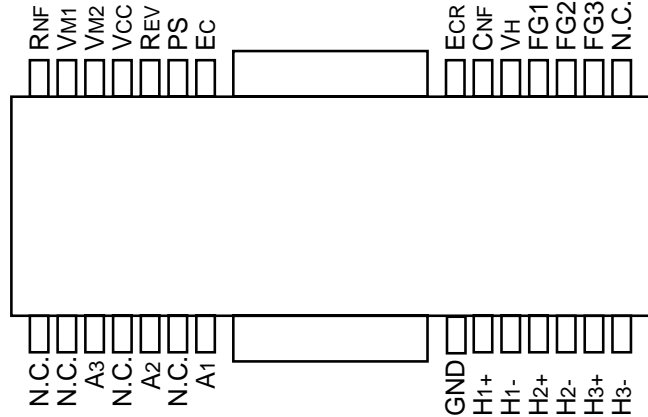

Pin description

PIN No	PIN NAME	DESCRIPTION
1	N.C.	Not connected
2	N.C.	Not connected
3	A3	Output 3 for motor
4	N.C.	Not connected
5	A2	Output 2 for motor
6	N.C.	Not connected
7	A1	Output 1 for motor
8	GND	Ground
9	H1+	Hall input Amp1. positive input
10	H1-	Hall input Amp1. negative input
11	H2+	Hall input Amp2. positive input
12	H2-	Hall input Amp2. negative input
13	H3+	Hall input Amp3. positive input
14	H3-	Hall input Amp3. negative input
15	N.C.	Not connected
16	FG3	FG3 signal output terminal
17	FG2	FG2 signal output terminal
18	FG1	FG1 signal output terminal
19	VH	Hall Bias
20	CNF	Capacitor connection pin for phase compensation
21	ECR	Torque control standard voltage input terminal
22	EC	Torque control voltage input terminal
23	PS	POWER SAVE switch
24	REV	Reverse terminal
25	VCC	Power supply for signal division
26	VM2	Power supply 2 for driver
27	VM1	Power supply 2 for driver
28	RNF	Power supply for driver division

SAA7335

DSP for CD and DVD-ROM system

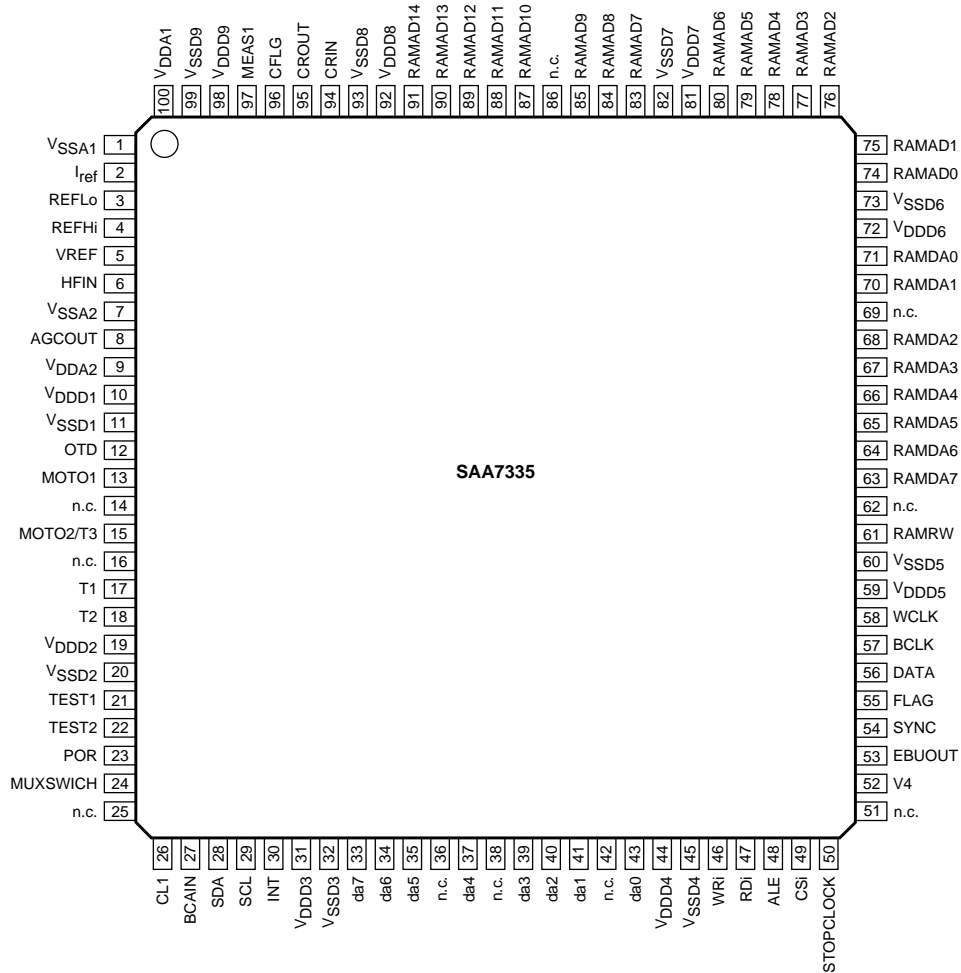
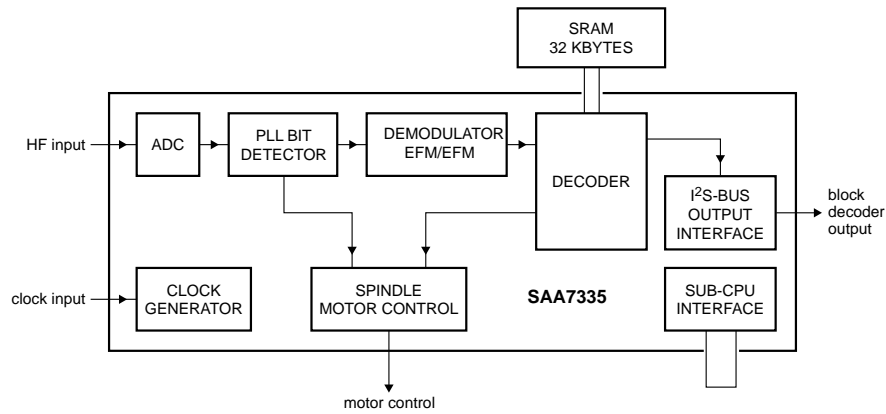

DVD-S520/DV-S5450

SAA7335**DSP for CD and DVD-ROM system****Pin description**

SYMBOL	PIN	TYPE	DESCRIPTION
VSSA1	1	supply	analog ground 1
Iref	2	I	analog current reference input for ADC
REFLo	3	I	analog low reference input for ADC
REFHi	4	I	analog high reference input for ADC
VREF	5	I	analog negative input
HFIN	6	I	analog positive input
VSSA2	7	supply	analog ground 2
AGCOUT	8	O	analog test pin output
VDDA2	9	supply	analog supply voltage 2
VDDD1	10	supply	digital supply voltage 1
VSSD1	11	supply	digital ground 1
OTD	12	I	off track detect input
MOTO1	13	O	3-state motor control output
n.c.	14	–	not connected, reserved
MOTO2/T3	15	I/O	motor control output/tachometer 3 input
n.c.	16	–	not connected, reserved
T1	17	I	tachometer 1 input
T2	18	I	tachometer 2 input
VDDD2	19	supply	digital supply voltage 2
VSSD2	20	supply	digital ground 2
TEST1	21	I	test input 1
TEST2	22	I	test input 2
POR	23	I	power-on reset input
MUXSWICH	24	I	use clock multiplier input
n.c.	25	–	not connected, reserved
CL1	26	O	divided clock output
BCAIN	27	I	BCA input
SDA	28	I/O	sub-CPU I 2 C-bus serial data input/output
SCL	29	I	sub-CPU I 2 C-bus serial clock input
INT	30	O	sub-CPU interrupt output (open-drain)
VDDD3	31	supply	digital supply voltage 3
VSSD3	32	supply	digital ground 3
da7	33	I/O	sub-CPU data bus bit 7 input/output (parallel)
da6	34	I/O	sub-CPU data bus bit 6 input/output (parallel)
da5	35	I/O	sub-CPU data bus bit 5 input/output (parallel)
n.c.	36	–	not connected, reserved
da4	37	I/O	sub-CPU data bus bit 4 input/output (parallel)
n.c.	38	–	not connected, reserved
da3	39	I/O	sub-CPU data bus bit 3 input/output (parallel)
da2	40	I/O	sub-CPU data bus bit 2 input/output (parallel)
da1	41	I/O	sub-CPU data bus bit 1 input/output (parallel)
n.c.	42	–	not connected, reserved
da0	43	I/O	sub-CPU data bus bit 0 input/output (parallel)
VDDD4	44	supply	digital supply voltage 4
VSSD4	45	supply	digital ground 4
WRi	46	I	sub-CPU write enable input (active LOW)
RD _i	47	I	sub-CPU read enable input (active LOW)
ALE	48	I	sub-CPU address latch enable input
CS _i	49	I	sub-CPU chip select input (active HIGH)
STOPCLOCK	50	O	stop clock output

SAA7335**DSP for CD and DVD-ROM system**

SYMBOL	PIN	TYPE	DESCRIPTION
n.c.	51	–	not connected, reserved
V4	52	O	serial subcode output (for CD)
EBUOUT	53	O	digital audio output
SYNC	54	O	I ² S-bus sector sync output
FLAG	55	O	I ² S-bus correction flag output
DATA	56	O	I ² S-bus serial data output
BCLK	57	I/O	I ² S-bus bit serial clock input/output
WCLK	58	I/O	I ² S-bus word clock input/output
VDDD5	59	supply	digital supply voltage 5
VSSD5	60	supply	digital ground 5
RAMRW	61	O	RAM read/write control output
n.c.	62	–	not connected, reserved
RAMDA7	63	I/O	RAM data bus bit 7 input/output
RAMDA6	64	I/O	RAM data bus bit 6 input/output
RAMDA5	65	I/O	RAM data bus bit 5 input/output
RAMDA4	66	I/O	RAM data bus bit 4 input/output
RAMDA3	67	I/O	RAM data bus bit 3 input/output
RAMDA2	68	I/O	RAM data bus bit 2 input/output
n.c.	69	–	not connected, reserved
RAMDA1	70	I/O	RAM data bus bit 1 input/output
RAMDA0	71	I/O	RAM data bus bit 0 input/output
VDDD6	72	supply	digital supply voltage 6
VSSD6	73	supply	digital ground 6
RAMAD0	74	O	RAM address bit 0 output
RAMAD1	75	O	RAM address bit 1 output
RAMAD2	76	O	RAM address bit 2 output
RAMAD3	77	O	RAM address bit 3 output
RAMAD4	78	O	RAM address bit 4 output
RAMAD5	79	O	RAM address bit 5 output
RAMAD6	80	O	RAM address bit 6 output
VDDD7	81	supply	digital supply voltage 7
VSSD7	82	supply	digital ground 7
RAMAD7	83	O	RAM address bit 7 output
RAMAD8	84	O	RAM address bit 8 output
RAMAD9	85	O	RAM address bit 9 output
n.c.	86	–	not connected, reserved
RAMAD10	87	O	RAM address bit 10 output
RAMAD11	88	O	RAM address bit 11 output
RAMAD12	89	O	RAM address bit 12 output
RAMAD13	90	O	RAM address bit 13 output
RAMAD14	91	O	RAM address bit 14 output
VDDD8	92	supply	digital supply voltage 8
VSSD8	93	supply	digital ground 8
CRIN	94	I	analog crystal input
CROUT	95	O	analog crystal output
CFLG	96	O	correction statistics output
MEAS1	97	O	front-end telemetry output
VDDD9	98	supply	digital supply voltage 9
VSSD9	99	supply	digital ground 9
VDDA1	100	supply	analog supply voltage 1

Am29LV160BT

16 MB (2 M x 8-bit / 1 M x 16-bit) CMOS 3.0 Volt-only Sector Erase Flash Memory

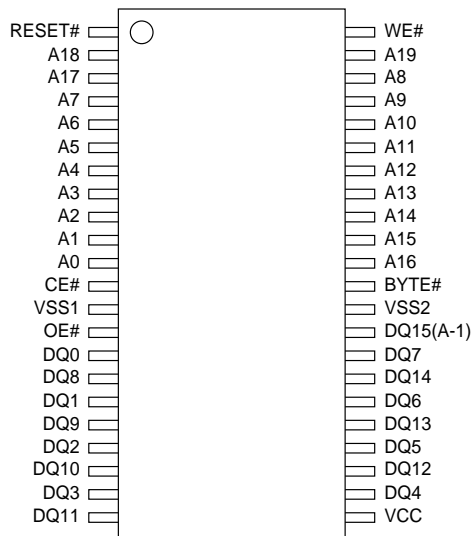
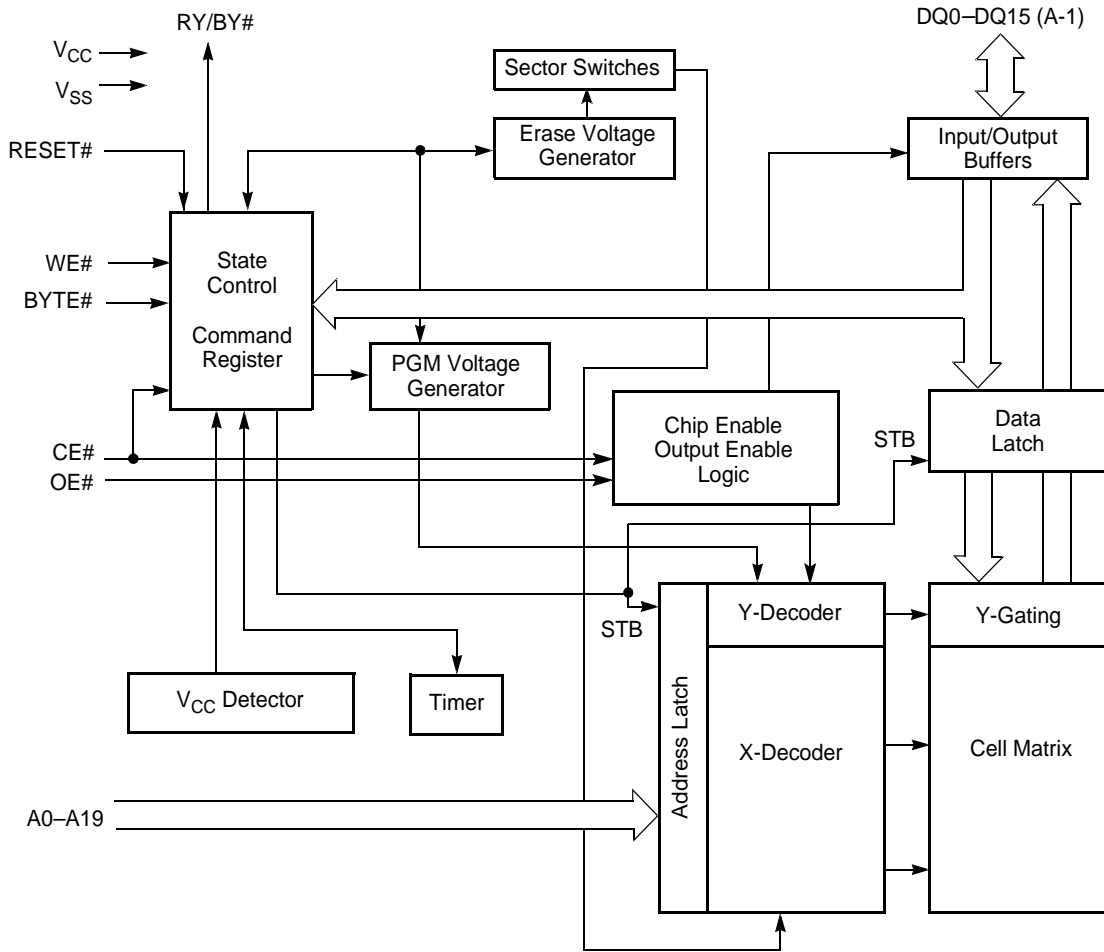

DVD-S520/DV-S5450

MT48LC1M16A1TG S

Synchronous DRAM

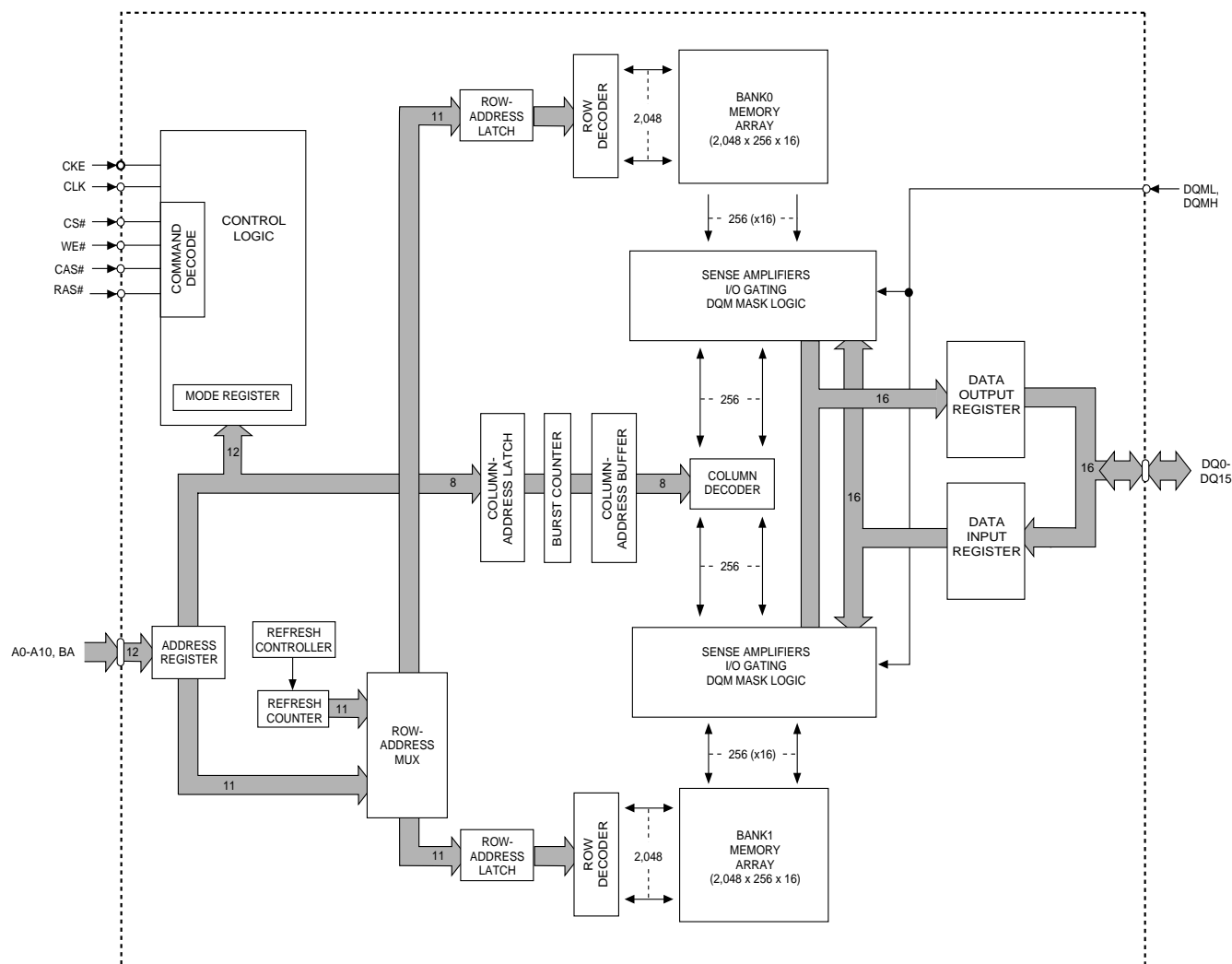
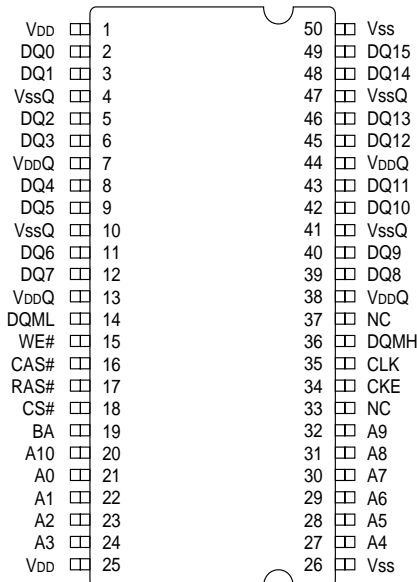

DVD-S520/DV-S5450

STi5508

DVD host processor with enhanced audio features

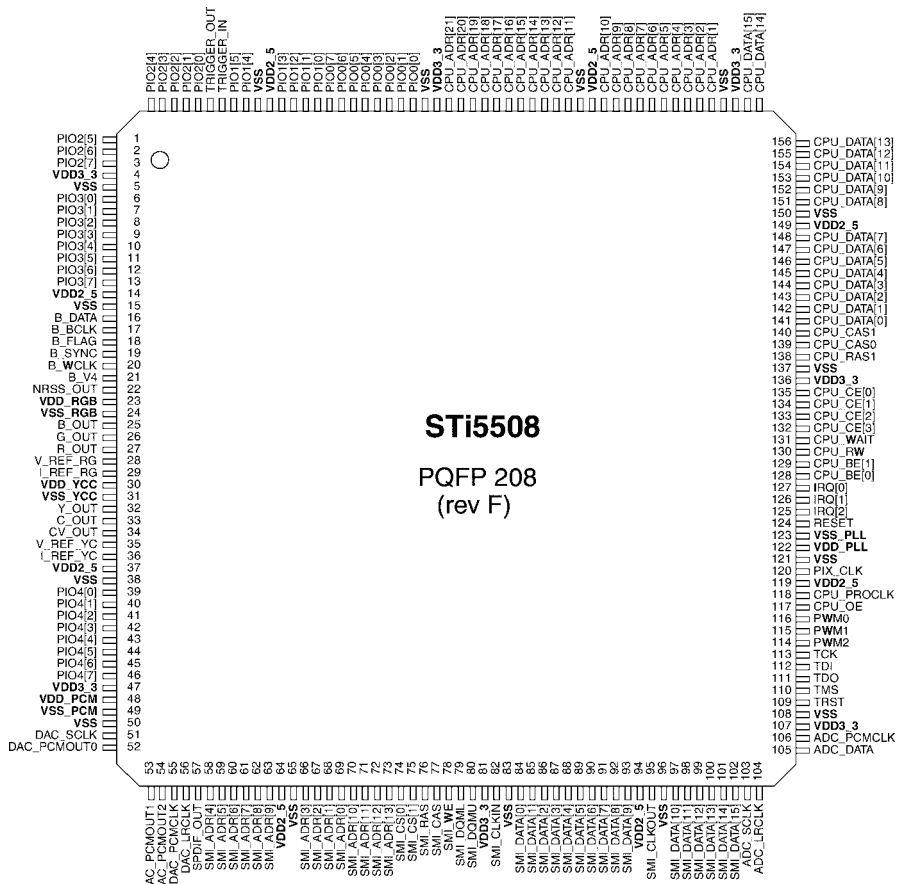
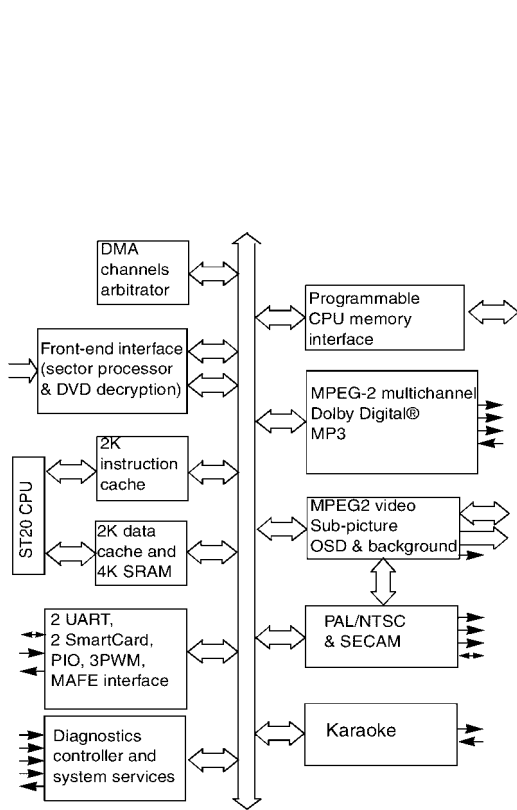

STi5508
PQFP 208
(rev F)

ST24E32 / ST25E32

32k serial I²C EEPROM with extended addressing

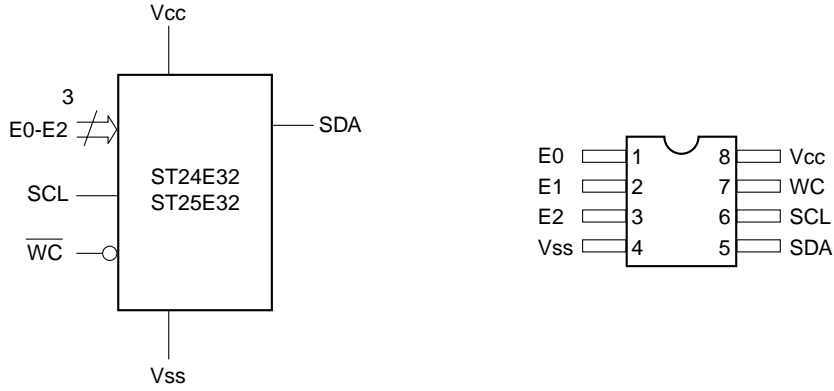

1 ■ WIRING DIAGRAM

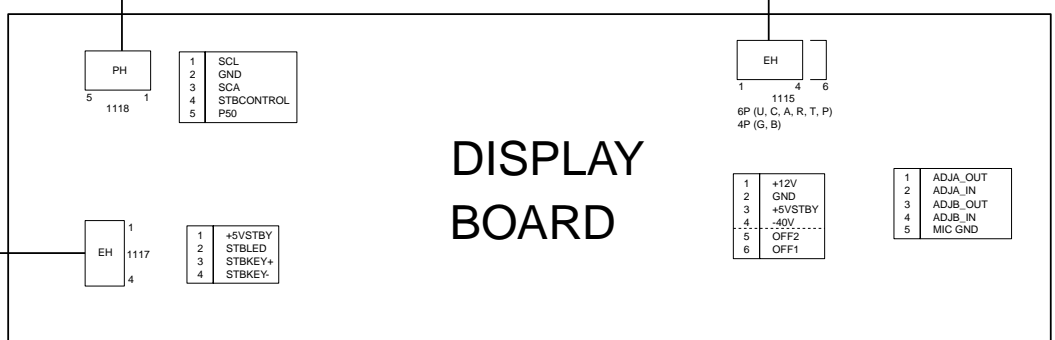
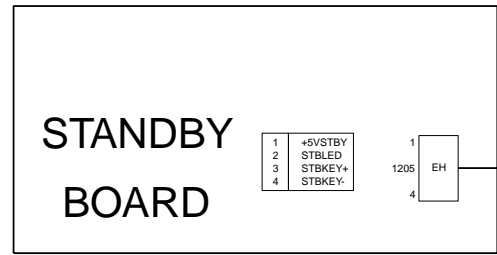
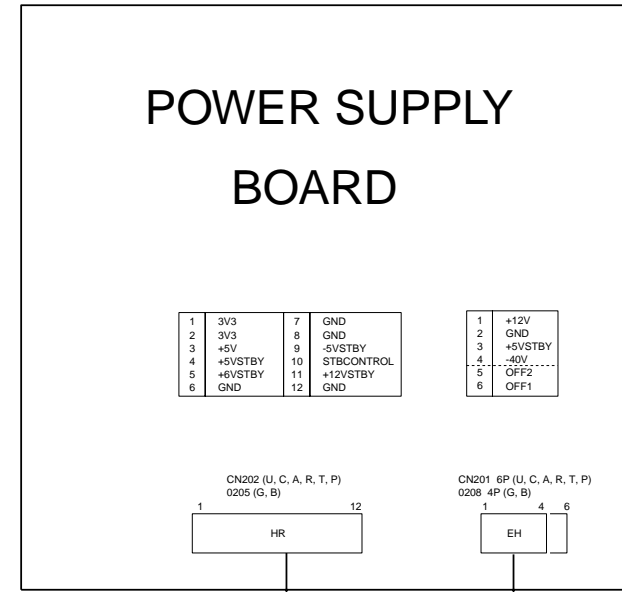
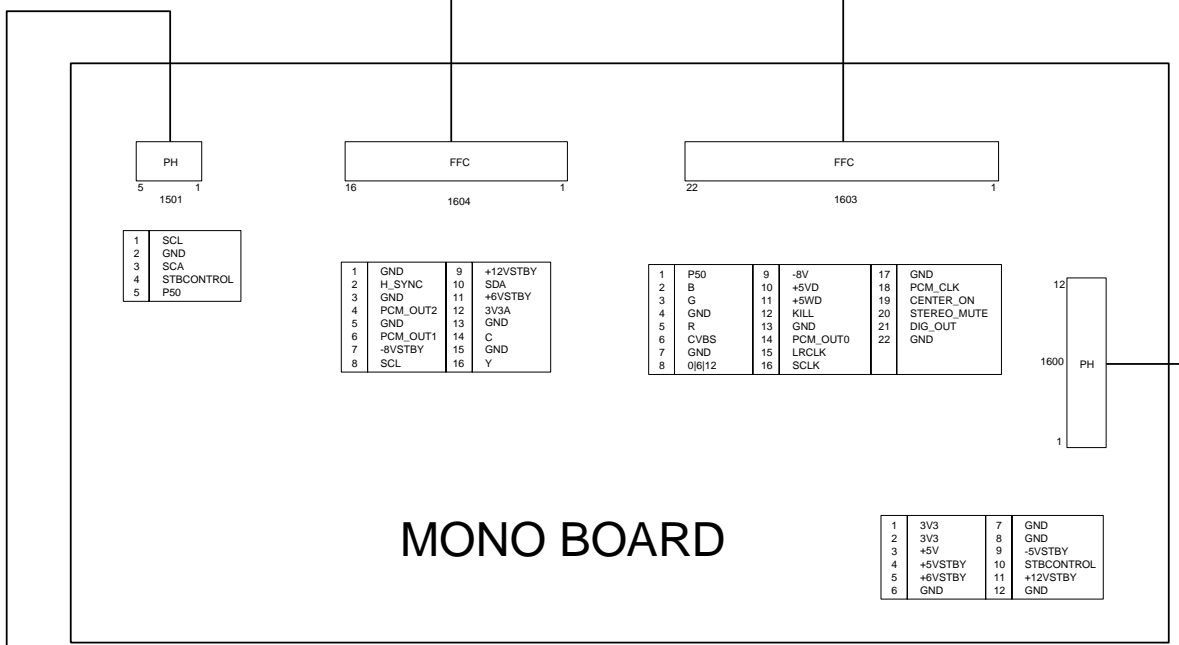
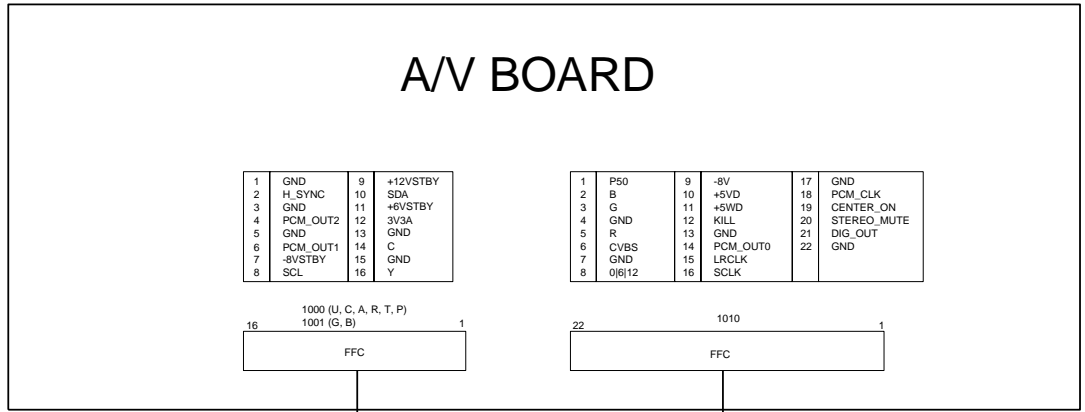

■ BLOCK DIAGRAM (U, C, A, R, T, P)

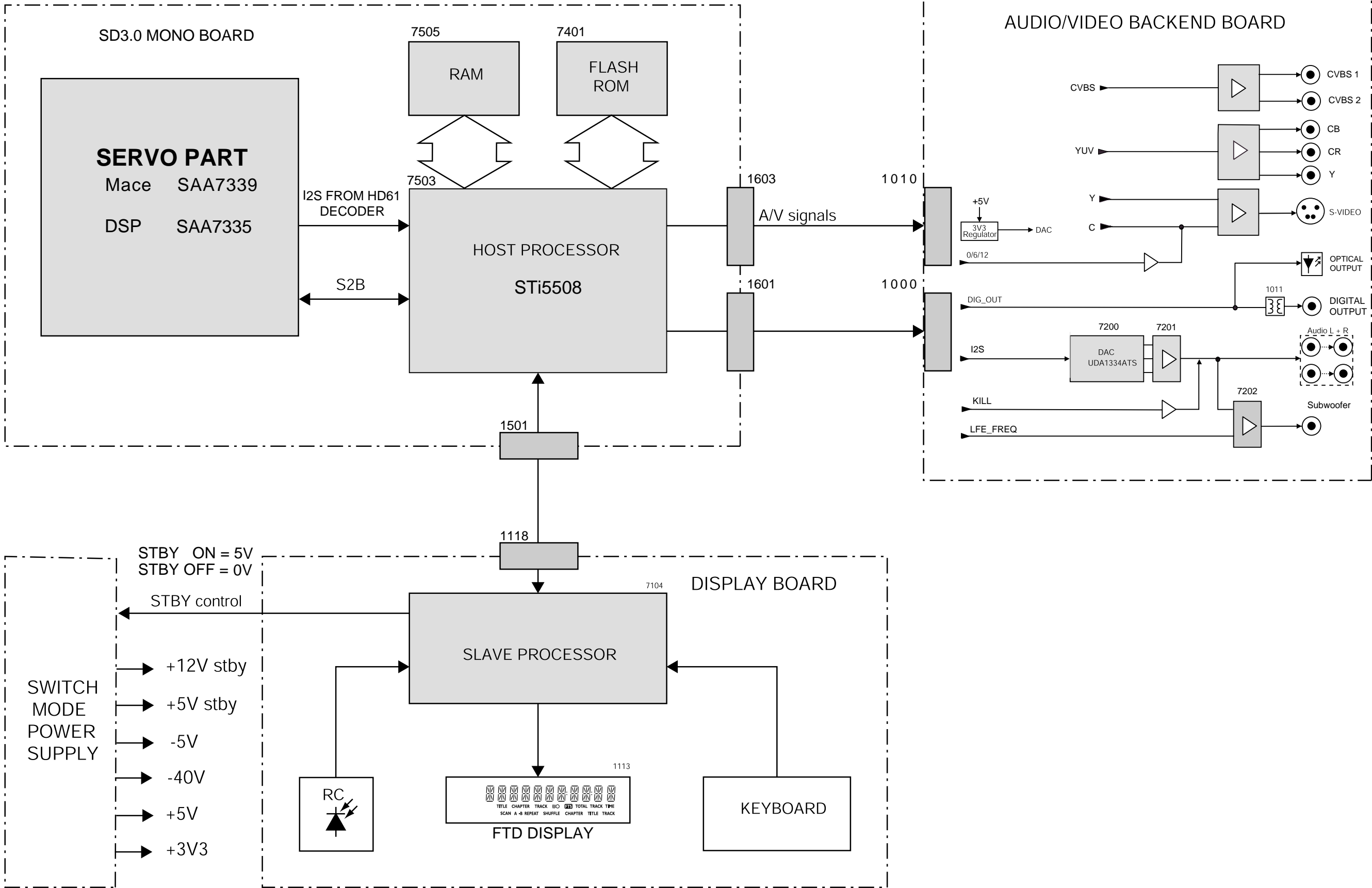

BLOCK DIAGRAM (B, G)

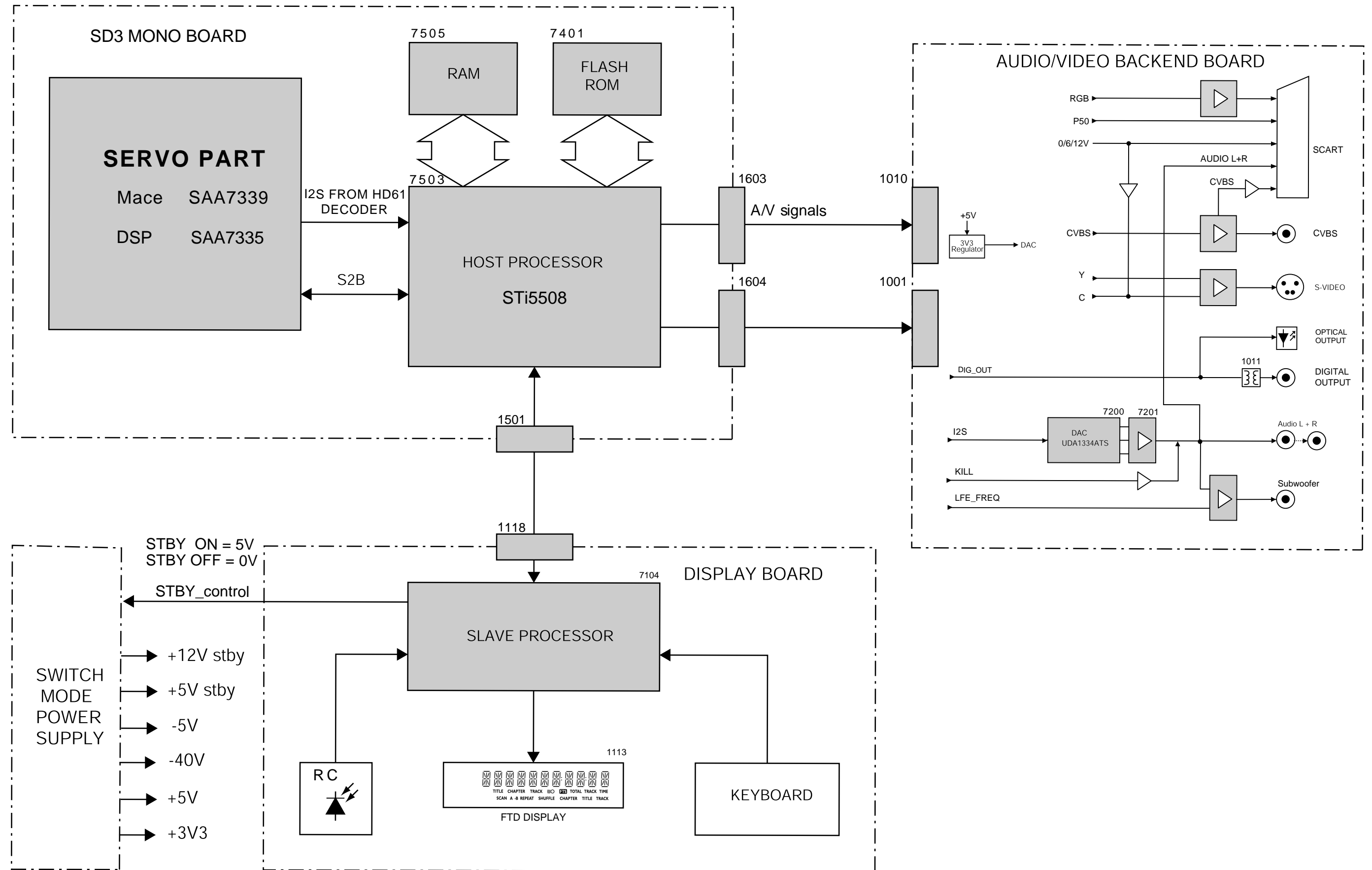

PRINTED CIRCUIT BOARD

MONO (Bottom view)

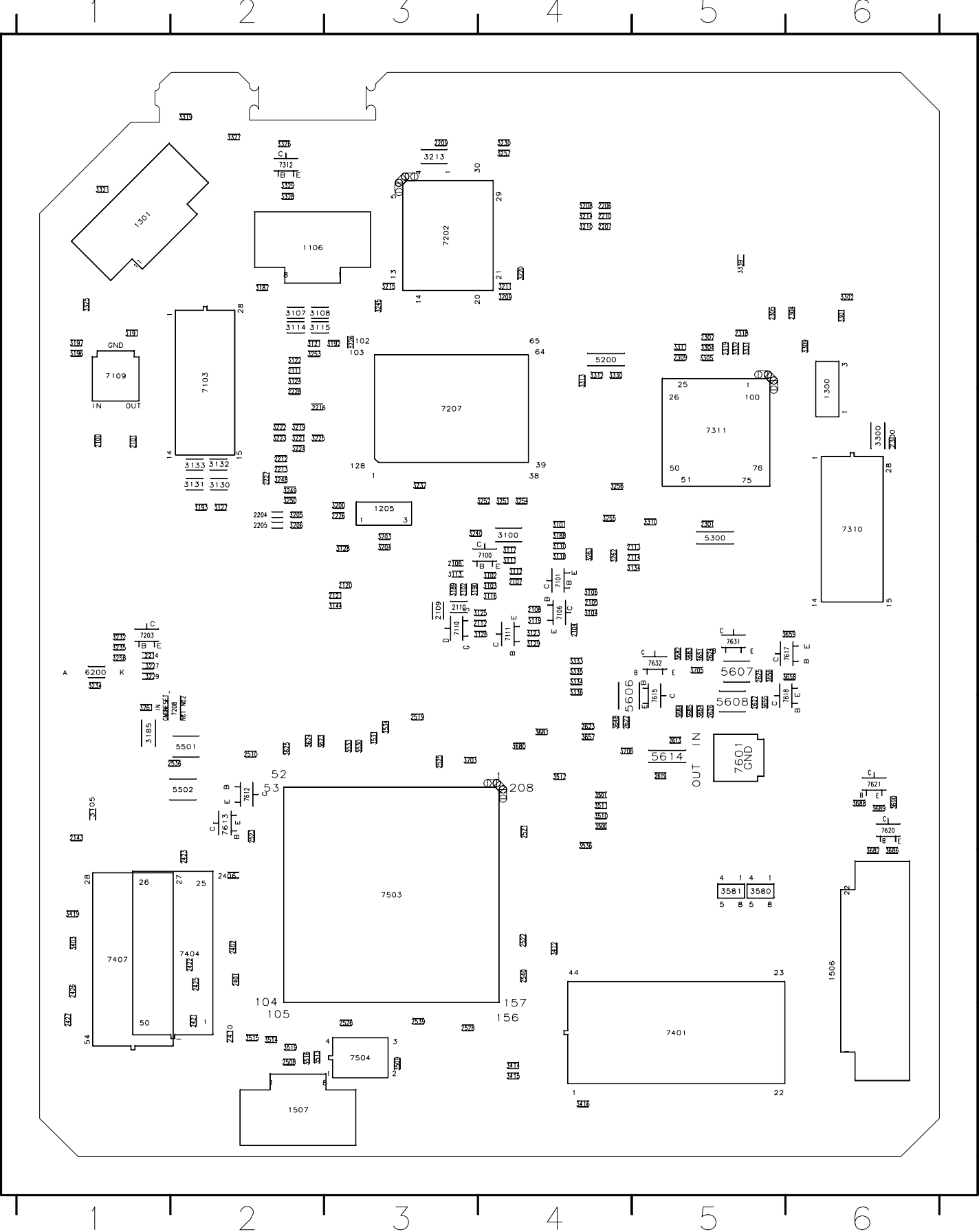

The first digit of a component indicates the component type.
1XXX : Connector 4XXX : SMD jumper 7XXX : Transistor, FET, IC
2XXX : Capacitor 5XXX : Coil 9XXX : Wire jumper
3XXX : Resistor 6XXX : Diode

1100	1101	1102	1103	1104	1105	1106	1107	1108	1109	1110	1111	1112	1113	1114	1115	1116	1117	1118	1119	1120	1121	1122	1123	1124	1125	1126	1127	1128	1129	1130	1131	1132	1133	1134	1135	1136	1137	1138	1139	1140	1141	1142	1143	1144	1145	1146	1147	1148	1149	1150	1151	1152	1153	1154	1155	1156	1157	1158	1159	1160	1161	1162	1163	1164	1165	1166	1167	1168	1169	1170	1171	1172	1173	1174	1175	1176	1177	1178	1179	1180	1181	1182	1183	1184	1185	1186	1187	1188	1189	1190	1191	1192	1193	1194	1195	1196	1197	1198	1199	1200
------	------	------	------	------	------	------	------	------	------	------	------	------	------	------	------	------	------	------	------	------	------	------	------	------	------	------	------	------	------	------	------	------	------	------	------	------	------	------	------	------	------	------	------	------	------	------	------	------	------	------	------	------	------	------	------	------	------	------	------	------	------	------	------	------	------	------	------	------	------	------	------	------	------	------	------	------	------	------	------	------	------	------	------	------	------	------	------	------	------	------	------	------	------	------	------	------	------	------	------	------

MONO BOARD only
The second digit of a component indicates the number of the schematic diagram.
E.g. IC7503 is on the schematic diagram 5.
E.g. R3100 is on the schematic diagram 1.

PRINTED CIRCUIT BOARD
MONO (Detailed bottom view 1/2)

MONO BOARD only
The second digit of a component indicates the number of the schematic diagram.
E.g. IC7503 is on the schematic diagram 5.
E.g. R3100 is on the schematic diagram 1.

The first digit of a component indicates the component type.
1XXX : Connector 4XXX : SMD jumper 7XXX : Transistor, FET, IC
2XXX : Capacitor 5XXX : Coil 8XXX : Wire jumper
3XXX : Resistor 6XXX : Diode

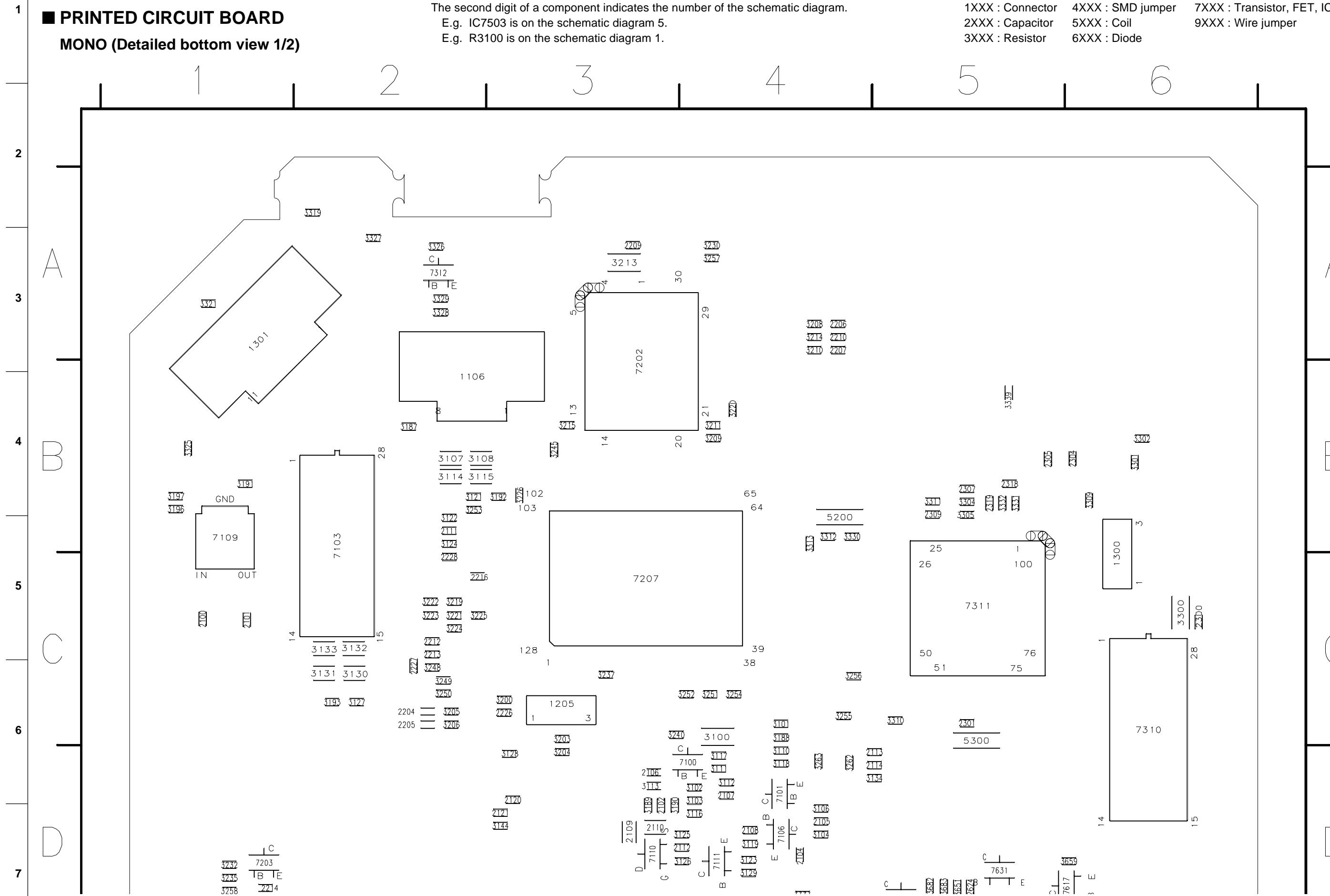

MONO BOARD only

The second digit of a component indicates the number of the schematic diagram.

E.g. IC7503 is on the schematic diagram 5.

E.g. R3100 is on the schematic diagram 1.

The first digit of a component indicates the component type.

1XXX : Connector 4XXX : SMD jumper 7XXX : Transistor, FET, IC

2XXX : Capacitor 5XXX : Coil

9XXX : Wire jumper

3XXX : Resistor 6XXX : Diode

PRINTED CIRCUIT BOARD

MONO (Detailed bottom view 2/2)

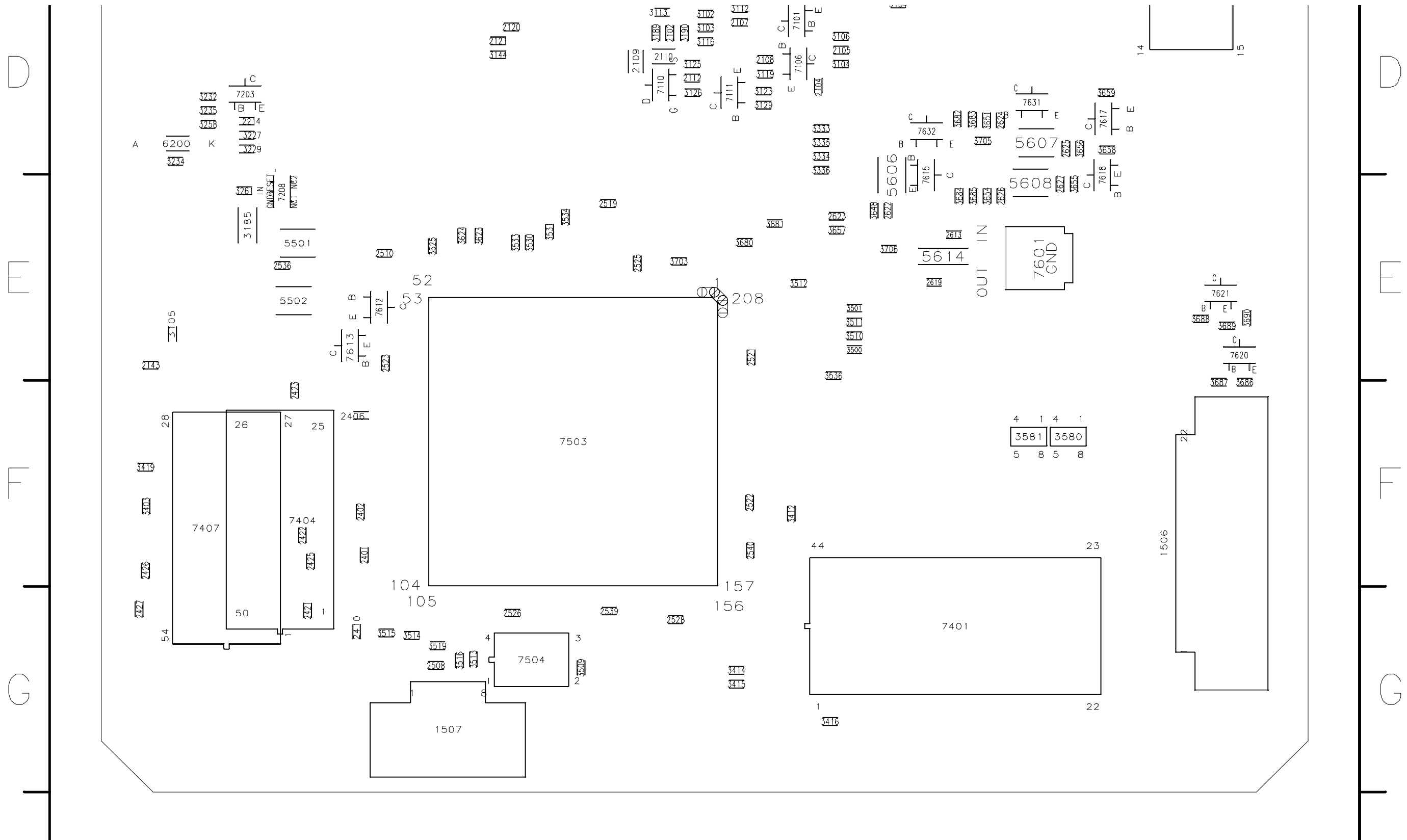

MONO BOARD only

The second digit of a component indicates the number of the schematic diagram.

E.g. IC7503 is on the schematic diagram 5.

E.g. R3100 is on the schematic diagram 1.

The first digit of a component indicates the component type.

1XXX : Connector

4XXX : SMD jumper

7XXX : Transistor, FET, IC

2XXX : Capacitor

5XXX : Coil

9XXX : Wire jumper

3XXX : Resistor

6XXX : Diode

PRINTED CIRCUIT BOARD MONO (Detailed top view 1/2)

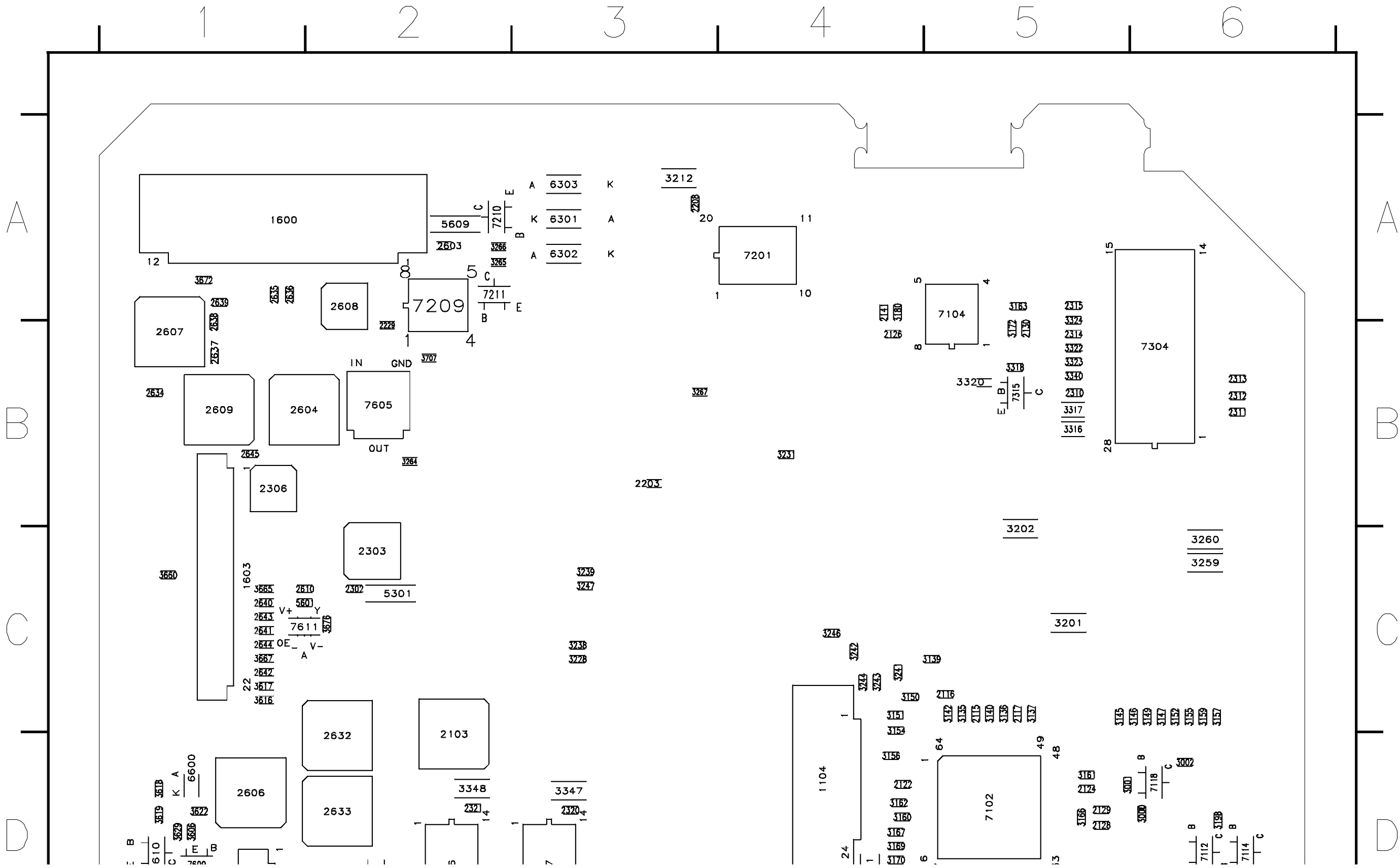

PRINTED CIRCUIT BOARD
MONO (Detailed top view 2/2)

MONO BOARD only
 The second digit of a component indicates the number of the schematic diagram.
 E.g. IC7503 is on the schematic diagram 5.
 E.g. R3100 is on the schematic diagram 1.

The first digit of a component indicates the component type.
 1XXX : Connector 4XXX : SMD jumper 7XXX : Transistor, FET, IC
 2XXX : Capacitor 5XXX : Coil 8XXX : Wire jumper
 3XXX : Resistor 6XXX : Diode

1
2
3
4
5
6
7

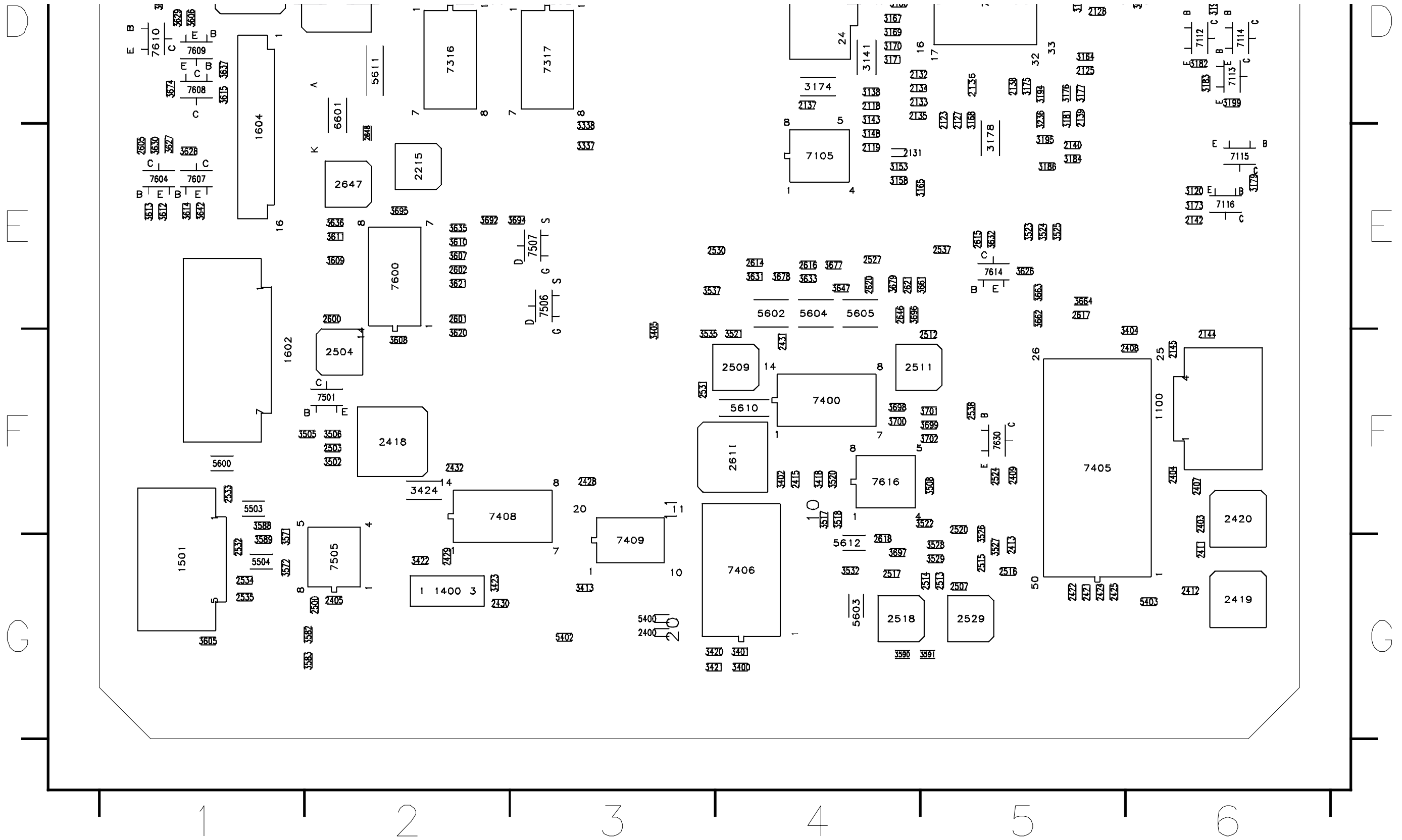

TEST POINT OVERVIEW

The first digit of a component indicates the component type.

1XXX : Connector 4XXX : SMD jumper 7XXX : Transistor, FET, IC

2XXX : Capacitor 5XXX : Coil 9XXX : Wire jumper

3XXX : Resistor 6XXX : Diode

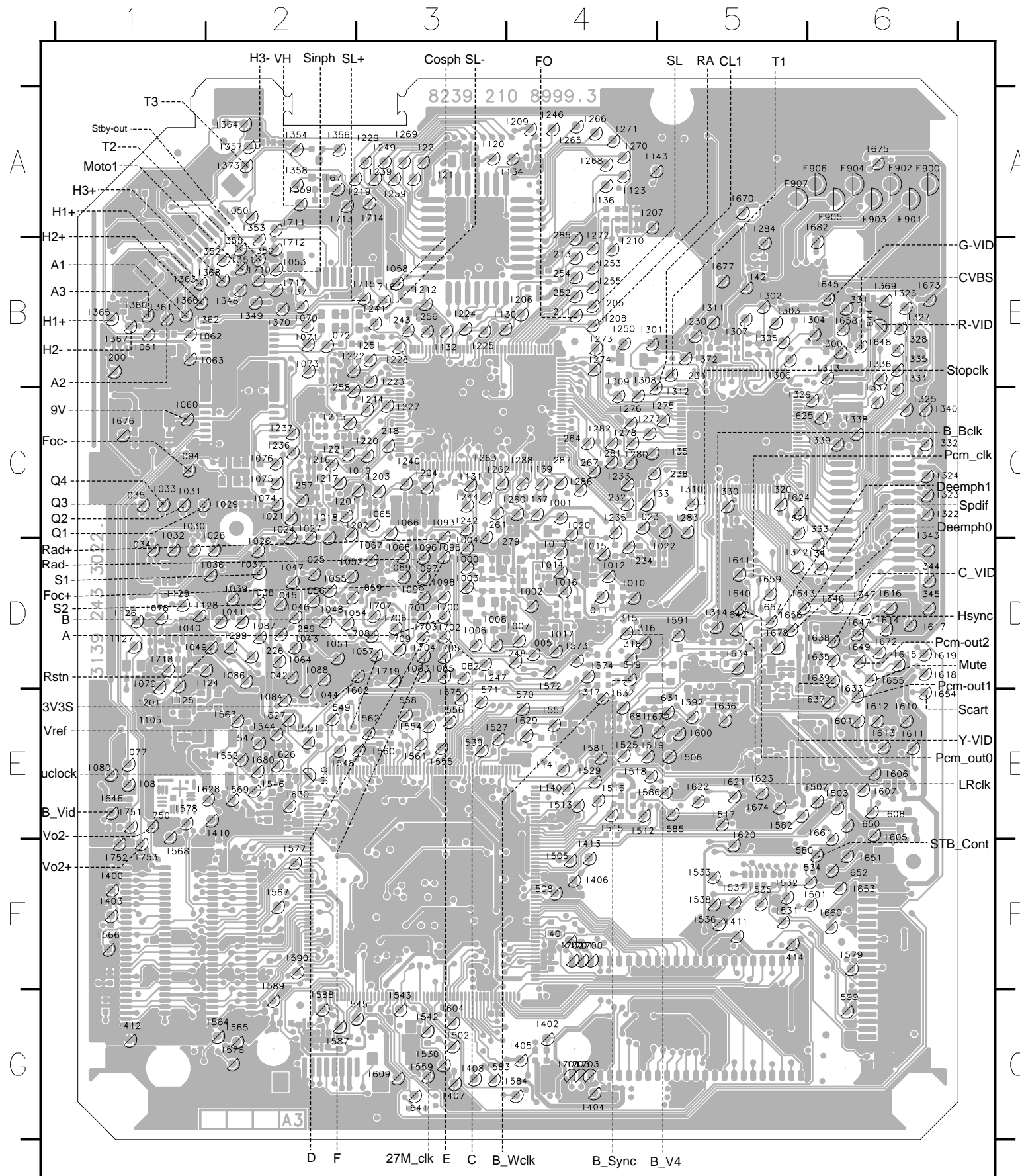

1105	F11	1105	D33	1105	F11	1105	D33
1201	F16	1201	D33	1201	F16	1201	D33
1605	F06	1605	D33	1605	F06	1605	D33
1606	F06	1606	D33	1606	F06	1606	D33
1607	F06	1607	D33	1607	F06	1607	D33
1608	F06	1608	D33	1608	F06	1608	D33
1700	F04	1700	D33	1700	F04	1700	D33
1701	F04	1701	D33	1701	F04	1701	D33
1702	F04	1702	D33	1702	F04	1702	D33
1703	G04	1703	D33	1703	G04	1703	D33
1704	G04	1704	D33	1704	G04	1704	D33
1705	G04	1705	D33	1705	G04	1705	D33
1900	A06	1900	D33	1900	A06	1900	D33
1901	A06	1901	D33	1901	A06	1901	D33
1902	A06	1902	D33	1902	A06	1902	D33
1903	A06	1903	D33	1903	A06	1903	D33
1904	A06	1904	D33	1904	A06	1904	D33
1905	A06	1905	D33	1905	A06	1905	D33
1906	A06	1906	D33	1906	A06	1906	D33
1907	A05	1907	D33	1907	A05	1907	D33
2001	D03	2001	D33	2001	D03	2001	D33
2002	D04	2002	D33	2002	D04	2002	D33
2003	D03	2003	D33	2003	D03	2003	D33
2004	D03	2004	D33	2004	D03	2004	D33
2005	D04	2005	D33	2005	D04	2005	D33
2006	D03	2006	D33	2006	D03	2006	D33
2007	D03	2007	D33	2007	D03	2007	D33
2008	D03	2008	D33	2008	D03	2008	D33
2009	D03	2009	D33	2009	D03	2009	D33
2010	D04	2010	D33	2010	D04	2010	D33
2011	D04	2011	D33	2011	D04	2011	D33
2012	D04	2012	D33	2012	D04	2012	D33
2013	D04	2013	D33	2013	D04	2013	D33
2014	D04	2014	D33	2014	D04	2014	D33
2015	D04	2015	D33	2015	D04	2015	D33
2016	D04	2016	D33	2016	D04	2016	D33
2017	D04	2017	D33	2017	D04	2017	D33
2018	C02	2018	D33	2018	C02	2018	D33
2019	C03	2019	D33	2019	C03	2019	D33
2020	C04	2020	D33	2020	C04	2020	D33
2021	C02	2021	D33	2021	C02	2021	D33
2022	C05	2022	D33	2022	C05	2022	D33
2023	C04	2023	D33	2023	C04	2023	D33
2024	C02	2024	D33	2024	C02	2024	D33
2025	C04	2025	D33	2025	C04	2025	D33
2026	D02	2026	D33	2026	D02	2026	D33
2027	C04	2027	D33	2027	C04	2027	D33
2028	C02	2028	D33	2028	C02	2028	D33
2029	C04	2029	D33	2029	C04	2029	D33
2030	D01	2030	D33	2030	D01	2030	D33
2031	D01	2031	D33	2031	D01	2031	D33
2032	D01	2032	D33	2032	D01	2032	D33
2033	D01	2033	D33	2033	D01	2033	D33
2034	B01	2034	D33	2034	B01	2034	D33
2035	B01	2035	D33	2035	B01	2035	D33
2036	D02	2036	D33	2036	D02	2036	D33
2037	D02	2037	D33	2037	D02	2037	D33
2038	D02	2038	D33	2038	D02	2038	D33
2039	D02	2039	D33	2039	D02	2039	D33
2040	D02	2040	D33	2040	D02	2040	D33
2041	D02	2041	D33	2041	D02	2041	D33
2042	D02	2042	D33	2042	D02	2042	D33
2043	D02	2043	D33	2043	D02	2043	D33
2044	D02	2044	D33	2044	D02	2044	D33
2045	D02	2045	D33	2045	D02	2045	D33
2046	D02	2046	D33	2046	D02	2046	D33
2047	D02	2047	D33	2047	D02	2047	D33
2048	D02	2048	D33	2048	D02	2048	D33
2049	D02	2049	D33	2049	D02	2049	D33
2050	D02	2050	D33	2050	D02	2050	D33
2051	D02	2051	D33	2051	D02	2051	D33
2052	D02	2052	D33	2052	D02	2052	D33
2053	D02	2053	D33	2053	D02	2053	D33
2054	D02	2054	D33	2054	D02	2054	D33
2055	D02	2055	D33	2055	D02	2055	D33
2056	D02	2056	D33	2056	D02	2056	D33
2057	D03	2057	D33	2057	D03	2057	D33
2058	D03	2058	D33	2058	D03	2058	D33

The first digit of a component indicates the component type.
 1XXX : Connector 4XXX : SMD jumper 7XXX : Transistor, FET, IC
 2XXX : Capacitor 5XXX : Coil 9XXX : Wire jumper
 3XXX : Resistor 6XXX : Diode

PRINTED CIRCUIT BOARD
AV (Component side) (U, C, A, R, T, P)

1000 A8	1010 B5	1601 D8	2103 A15	2112 B13	2205 A10	2216 B6	2227 A6	3204 B5	3235 C5	5200 C3	7203 B2	9301 B3	9305 C6	9309 A12	9313 A14	9317 A14
1003 D15	1011 D3	1602 D9	2106 B16	2201 A5	2206 B5	2220 B10	2232 C4	3214 B8	5100 C13	5201 C9	7204 D4	9302 B4	9306 B6	9310 A12	9314 A15	9318 B3
1005 C8	1012 D6	2100 A2	2109 B12	2202 C4	2208 B1	2225 A10	2236 C10	3216 B8	5101 C12	5202 D10	9104 C15	9303 B6	9307 C10	9311 C12	9315 A15	
1006 D13	1600 D7	2101 A2	2111 B11	2204 A16	2211 C7	2226 B7	2237 C1	3234 D5	5102 C11	7100 A2	9300 A3	9304 A11	9308 A11	9312 A14	9316 C14	

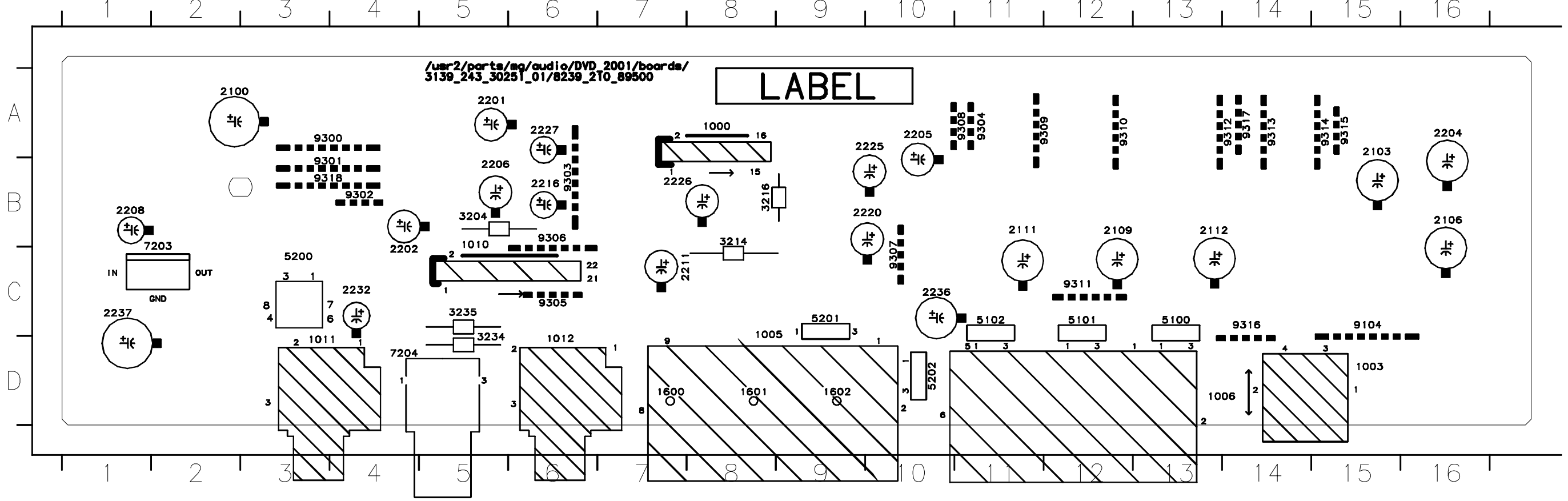

PRINTED CIRCUIT BOARD

AV (Overview bottom side) (U, C, A, R, T, P)

The first digit of a component indicates the component type.

1XXX : Connector 4XXX : SMD jumper 7XXX : Transistor, FET, IC

2XXX : Capacitor 5XXX : Coil 9XXX : Wire jumper

3XXX : Resistor 6XXX : Diode

22102	22213	22330	D8	31	103	C2	51	11	33	31	32	4103	4102	7414	7426	7511	C7
22104	22214	22333	D11	31	104	C3	51	11	33	31	32	4104	4103	7415	7427	7512	D15
22105	22215	22334	D12	31	105	C4	51	11	33	31	32	4105	4104	7416	7428		
22106	22216	22335	D13	31	106	C5	51	11	33	31	32	4106	4105	7417	7429		
22107	22217	22336	D14	31	107	C6	51	11	33	31	32	4107	4106	7418	7430		
22108	22218	22337	D15	31	108	C7	51	11	33	31	32	4108	4107	7419	7431		
22109	22219	22338	D16	31	109	C8	51	11	33	31	32	4109	4108	7420	7432		
22110	22220	22339	D17	31	110	C9	51	11	33	31	32	4110	4109	7421	7433		
22111	22221	22340	D18	31	111	C10	51	11	33	31	32	4111	4110	7422	7434		
22112	22222	22341	D19	31	112	C11	51	11	33	31	32	4112	4111	7423	7435		
22113	22223	22342	D20	31	113	C12	51	11	33	31	32	4113	4112	7424	7436		
22114	22224	22343	D21	31	114	C13	51	11	33	31	32	4114	4113	7425	7437		
22115	22225	22344	D22	31	115	C14	51	11	33	31	32	4115	4114	7425	7438		

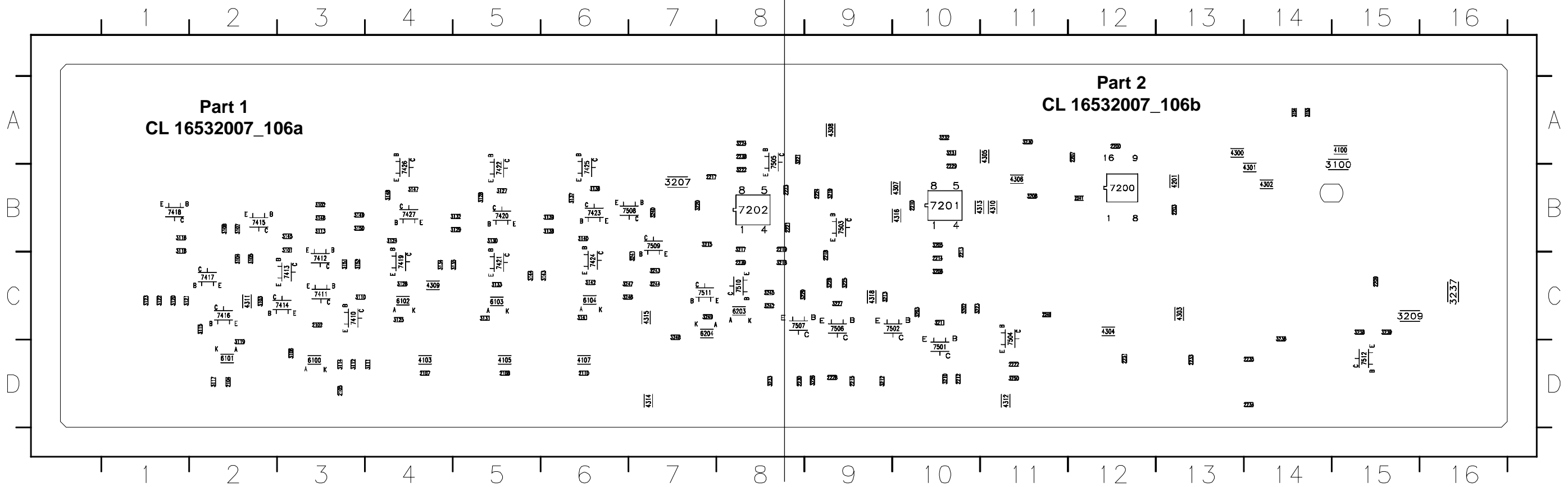

The first digit of a component indicates the component type.
 1XXX : Connector 4XXX : SMD jumper 7XXX : Transistor, FET, IC
 2XXX : Capacitor 5XXX : Coil 8XXX : Wire jumper
 3XXX : Resistor 6XXX : Diode

PRINTED CIRCUIT BOARD

AV (Part 1 bottom side) (U, C, A, R, T, P)

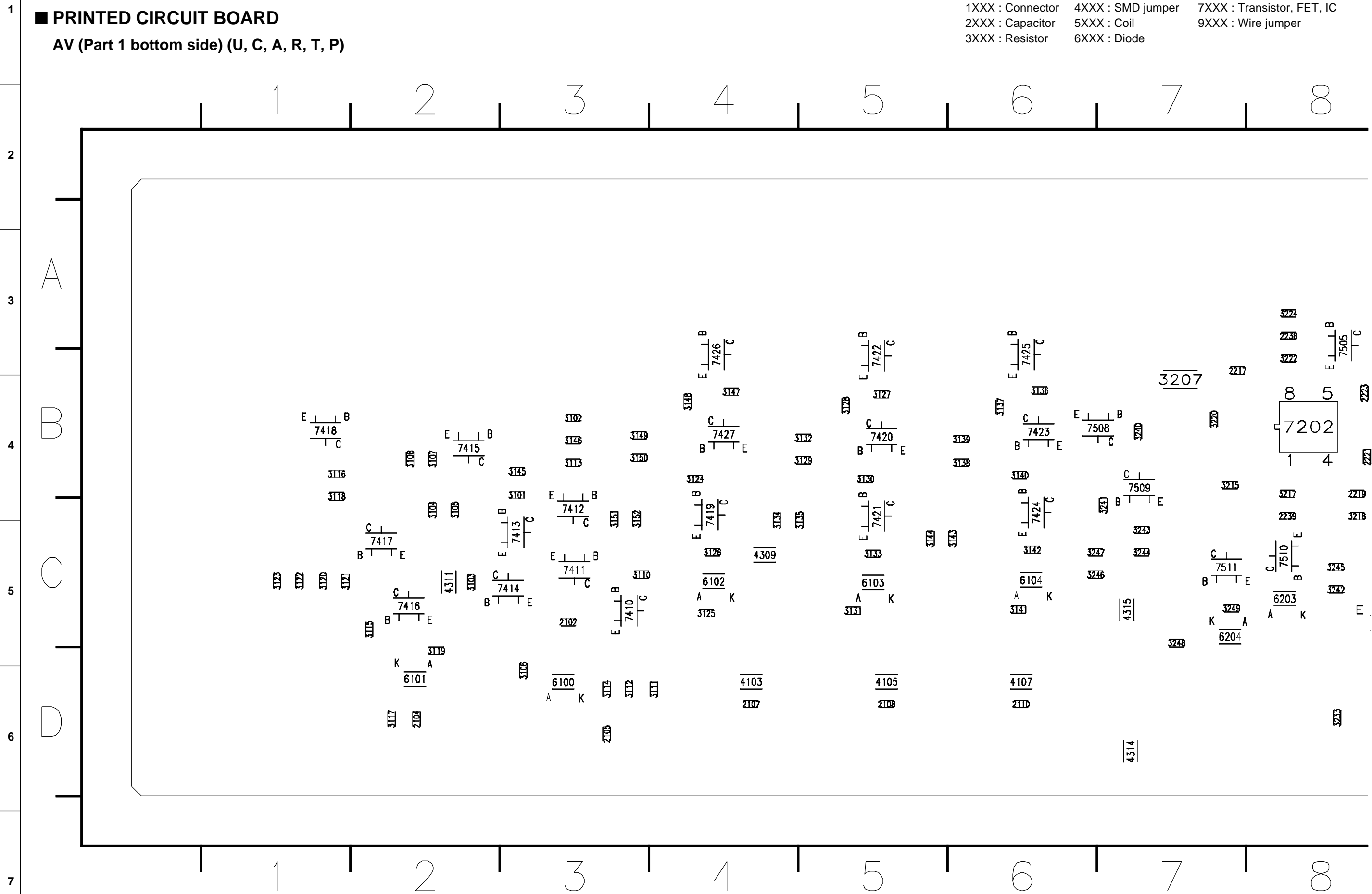

PRINTED CIRCUIT BOARD

AV (Part 2 bottom side) (U, C, A, R, T, P)

The first digit of a component indicates the component type.
 1XXX : Connector 4XXX : SMD jumper 7XXX : Transistor, FET, IC
 2XXX : Capacitor 5XXX : Coil 9XXX : Wire jumper
 3XXX : Resistor 6XXX : Diode

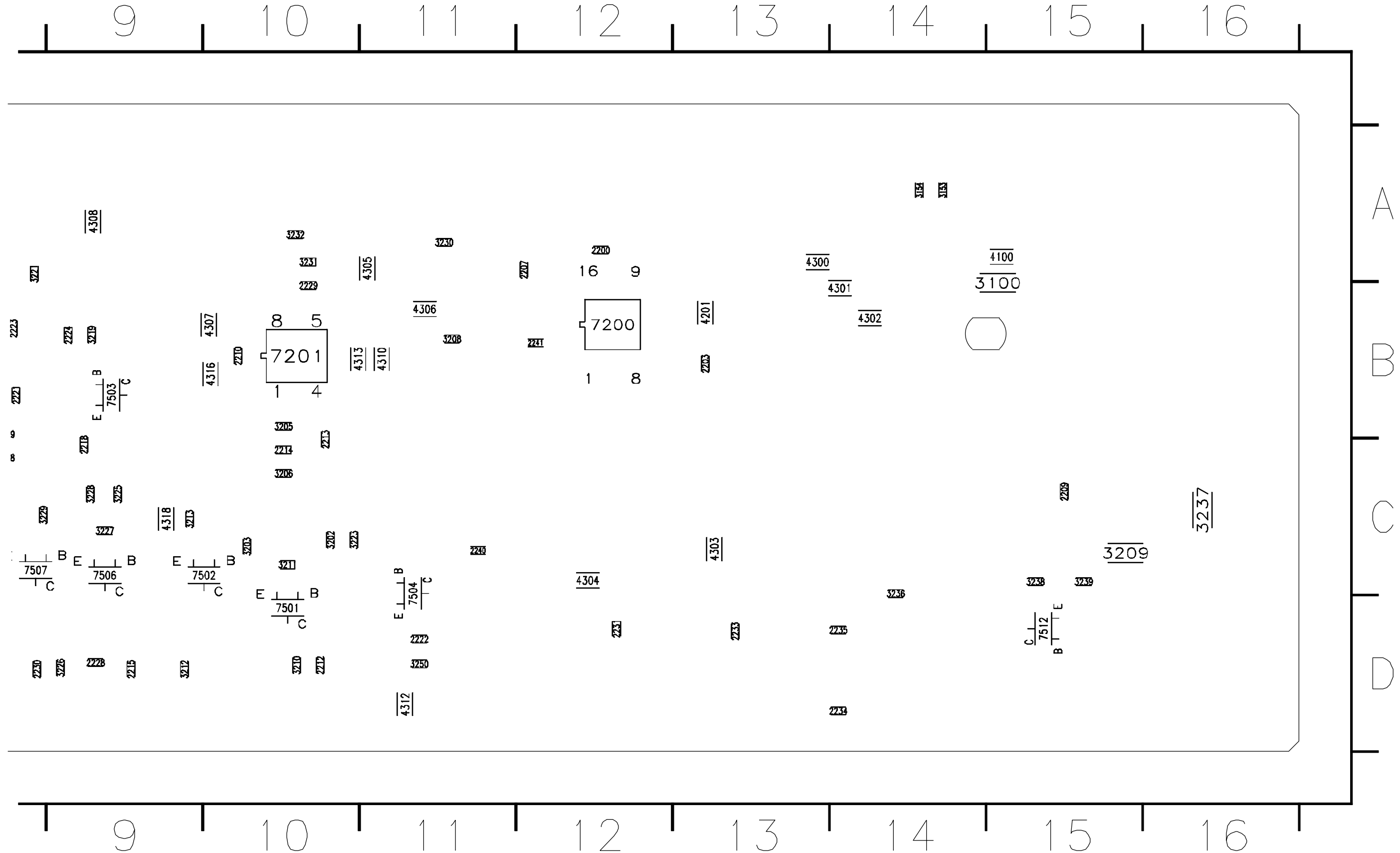

The first digit of a component indicates the component type.
 1XXX : Connector 4XXX : SMD jumper 7XXX : Transistor, FET, IC
 2XXX : Capacitor 5XXX : Coil 9XXX : Wire jumper
 3XXX : Resistor 6XXX : Diode

PRINTED CIRCUIT BOARD

AV (Component side) (B, G)

1001 A8	1010 B5	2101 A3	2109 B12	2205 B9	2220 C4	2236 D9	3145 A15	3221 D6	3235 C3	7204 D3	9304 C4	9310 A9	9316 B11	9321 A13	9327 C14	9332 B8
1002 D12	1011 D1	2103 B14	2114 C16	2206 B5	2225 C5	2237 B2	3149 A11	3223 B10	3251 B9	9300 A4	9305 B6	9311 A10	9317 A11	9322 A13	9328 B15	9333 C8
1003 C15	1012 D4	2104 B11	2201 A6	2208 B1	2226 B8	2242 B3	3159 A16	3228 B10	5200 C1	9301 B4	9306 C6	9313 C9	9318 A12	9323 B12	9329 C15	9334 A15
1004 B13	1013 B10	2105 C11	2202 B5	2211 C8	2227 A7	3143 A14	3203 C9	3229 D14	7100 A2	9302 B4	9307 B7	9314 C10	9319 A12	9324 C12	9330 A12	9335 A4
1005 D8	2100 A1	2108 A16	2204 A16	2216 B6	2232 C2	3144 A14	3204 B6	3234 C3	7203 B1	9303 B4	9309 A9	9315 C10	9320 A13	9326 B14	9331 B4	

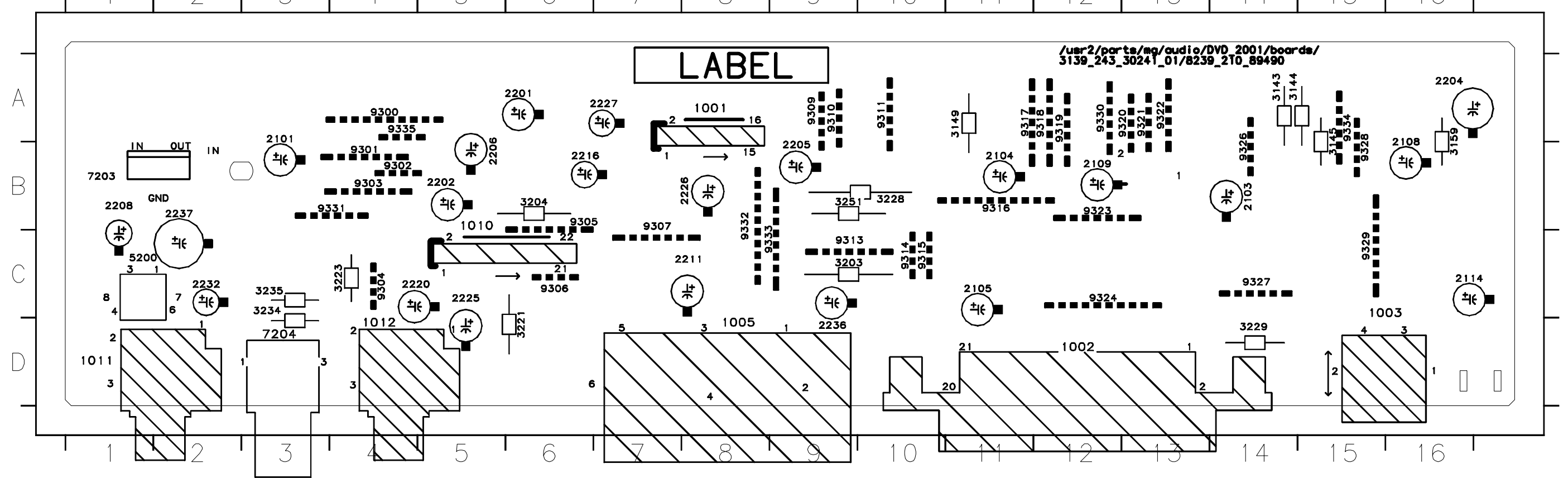

PRINTED CIRCUIT BOARD
AV (Part 1 bottom side) (B, G)

The first digit of a component indicates the component type.
 1XXX : Connector 4XXX : SMD jumper 7XXX : Transistor, FET, IC
 2XXX : Capacitor 5XXX : Coil 8XXX : Wire jumper
 3XXX : Resistor 6XXX : Diode

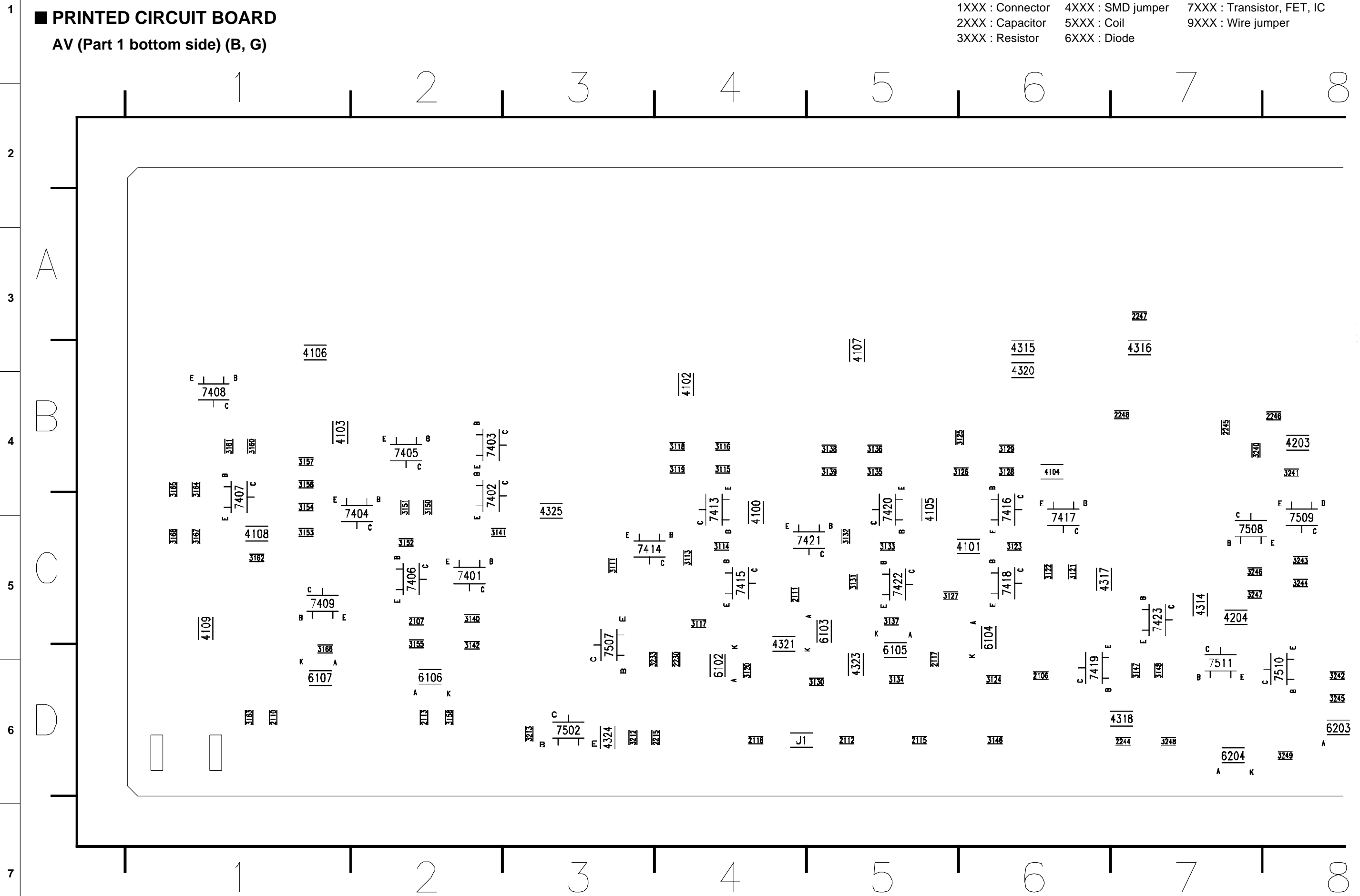

PRINTED CIRCUIT BOARD

AV (Part 2 bottom side) (B, G)

The first digit of a component indicates the component type.

1XXX : Connector 4XXX : SMD jumper 7XXX : Transistor, FET, IC

2XXX : Capacitor 5XXX : Coil 9XXX : Wire jumper

3XXX : Resistor 6XXX : Diode

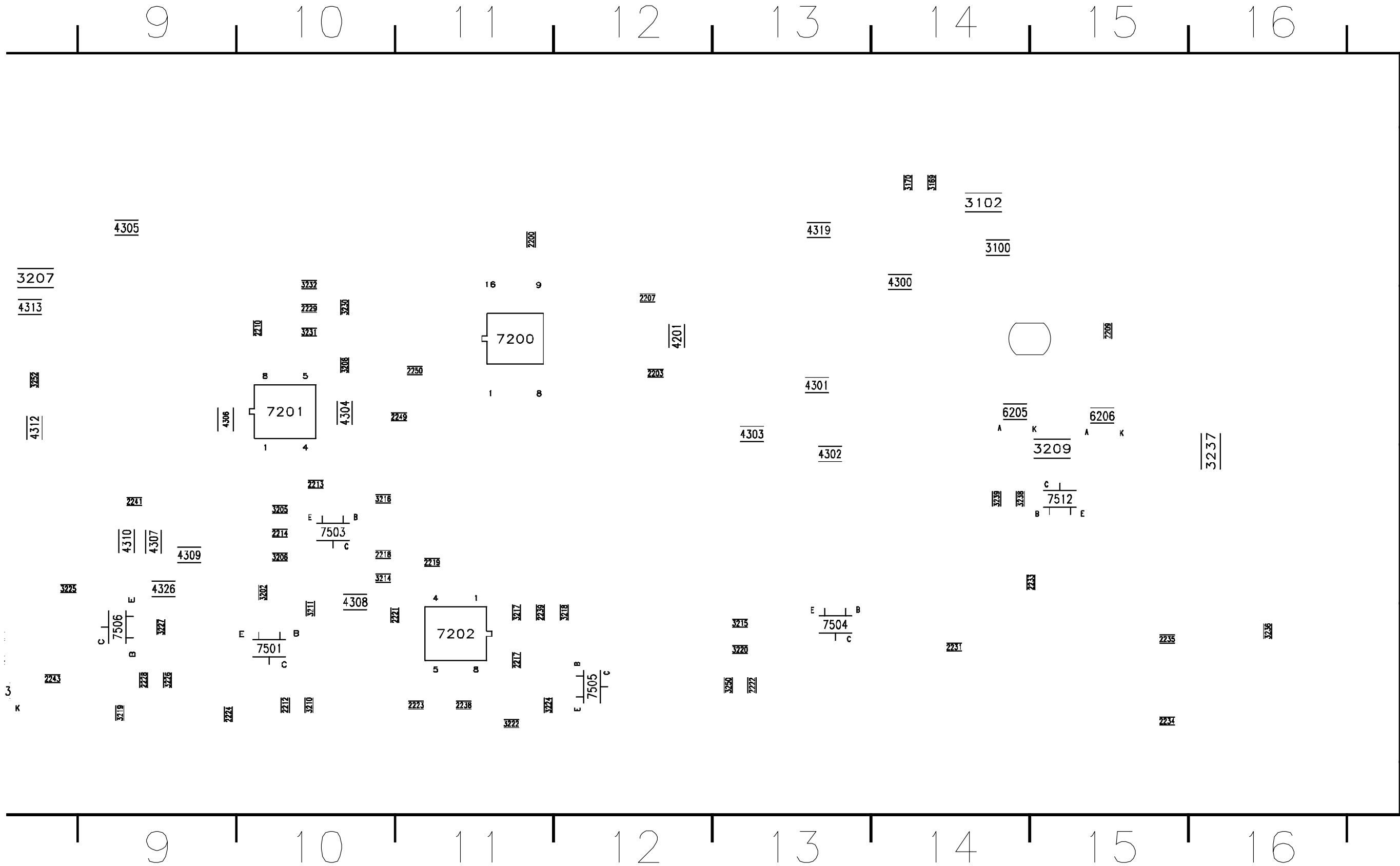

PRINTED CIRCUIT BOARD
DISPLAY (Part 1 bottom side)

The first digit of a component indicates the component type.
1XXX : Connector 4XXX : SMD jumper 7XXX : Transistor, FET, IC
2XXX : Capacitor 5XXX : Coil 9XXX : Wire jumper
3XXX : Resistor 6XXX : Diode

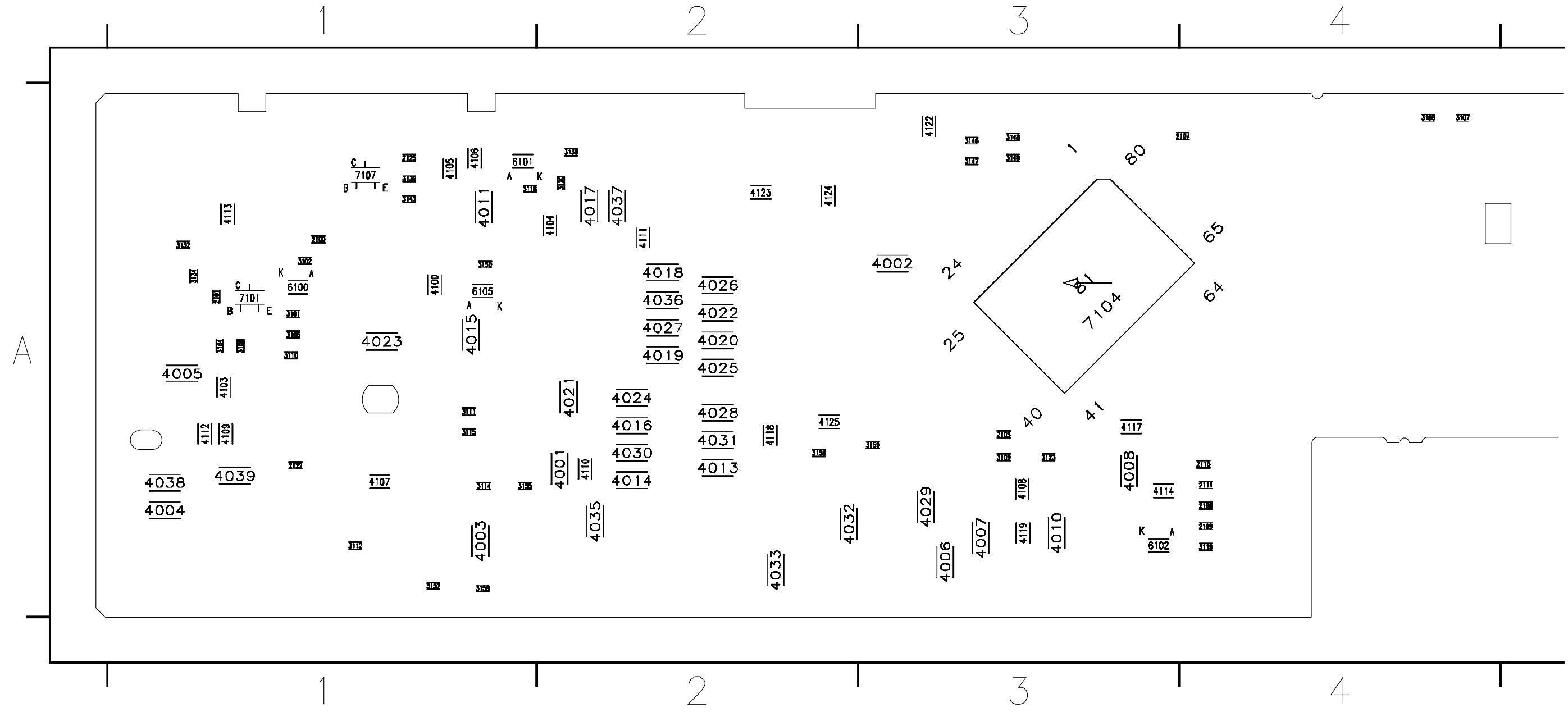

The first digit of a component indicates the component type.
 1XXX : Connector 4XXX : SMD jumper 7XXX : Transistor, FET, IC
 2XXX : Capacitor 5XXX : Coil 8XXX : Wire jumper
 3XXX : Resistor 6XXX : Diode

PRINTED CIRCUIT BOARD
DISPLAY (Part 2 bottom side)

1
2
3
4
5
6
7

5

6

7

8

9

X

3105 3108

4034

7108

4115

4120

4012

2120 3133 3142

7109

3132 3140

6104

4102

4126

2118

3111

4101

4121

3121

3130

3122

3125

2119

3122

2114

3122

3122

A

5

6

7

8

9

PRINTED CIRCUIT BOARD

POWER (Component side) (B, G)

The first digit of a component indicates the component type.

1XXX : Connector 4XXX : SMD jumper 7XXX : Transistor, FET, IC

2XXX : Capacitor 5XXX : Coil 9XXX : Wire jumper

3XXX : Resistor 6XXX : Diode

0101	B1	0209	A9	2121	B3	2130	A4	2135	C5	2232	A8	2240	A7	2259	C8	3111	C4	3123	B2	3133	A3	3201	C6	5120	A2	5210	C7	5260	A7	6120	B3	6128	A4	6211	C6	6241	A7	7125	B4	7201	C6	7259	C8	9203	B8	9259	C7
0125	C4	0299	A8	2122	C2	2131	C5	2141	C3	2233	A8	2241	A6	2260	A7	3112	C5	3126	B4	3134	C3	3232	B8	5121	B2	5222	C6	6110	C3	6121	A3	6132	C5	6230	B6	6250	B6	7131	C6	7233	A8	9122	C2	9204	C9		
0199	A4	1120	C1	2123	B3	2132	C5	2210	C7	2236	B6	2250	C6	2261	A7	3120	C1	3127	B4	3135	C5	3233	C8	5125	B4	5230	B7	6111	C3	6122	C3	6133	C5	6231	B6	6259	C7	7141	C3	7236	B7	9125	B4	9205	B9		
0205	C9	2119	B2	2127	B4	2133	C5	2211	B7	2238	B7	2251	B6	2263	A6	3121	C3	3128	B4	3140	B4	3262	C6	5131	B6	5231	B7	6118	A3	6123	B3	6140	C4	6233	C9	6260	A6	7145	C4	7237	B8	9201	C6	9206	B9		
0208	A9	2120	C2	2129	C4	2134	C5	2230	B7	2239	B8	2253	C7	3105	C1	3122	B2	3132	B4	3155	C4	3263	B8	5135	B5	5240	A7	6119	A2	6127	A4	6210	B7	6240	B6	6261	A6	7150	C3	7255	C7	9202	C8	9207	B9		

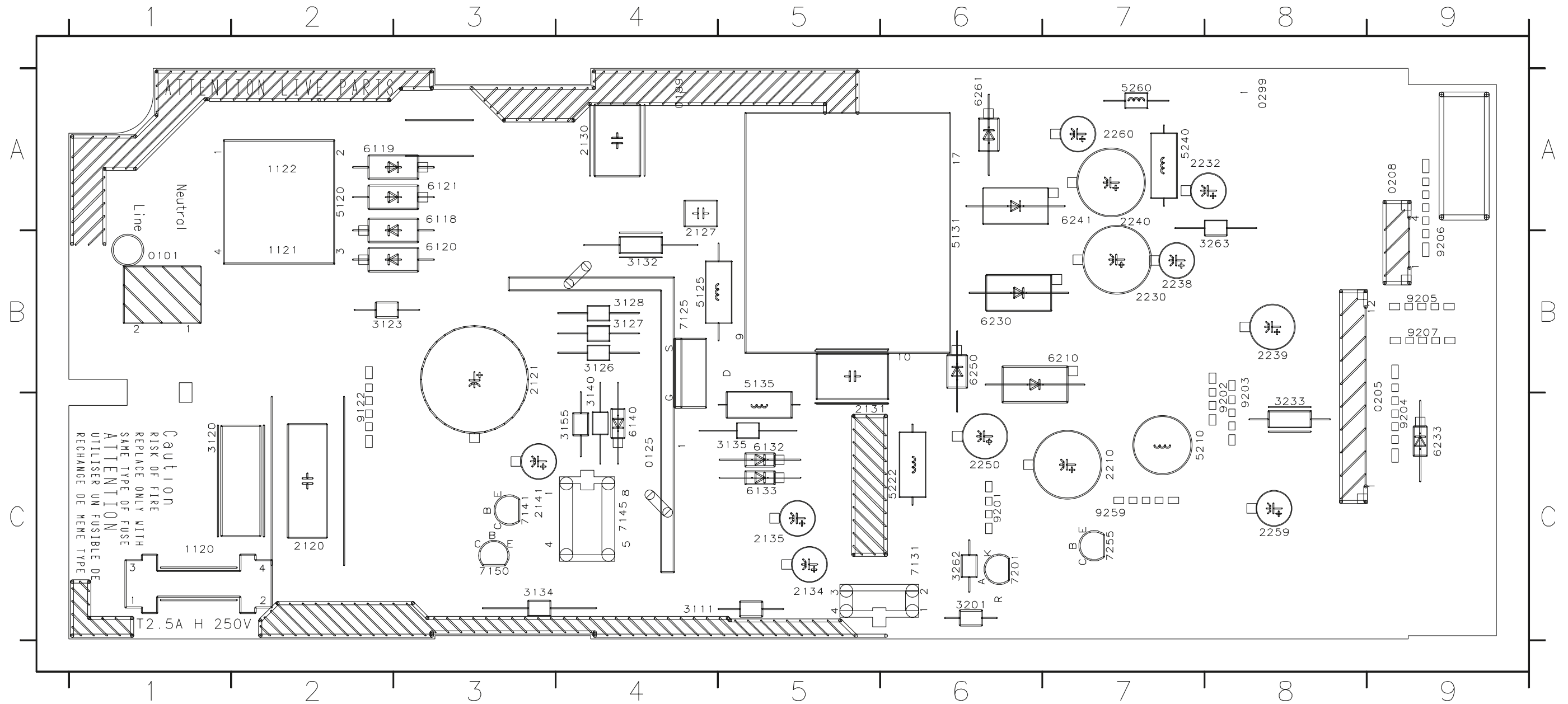

**PRINTED CIRCUIT BOARD
POWER (Bottom side) (B, G)**

The first digit of a component indicates the component type.
 1XXX : Connector 4XXX : SMD jumper 7XXX : Transistor, FET, IC
 2XXX : Capacitor 5XXX : Coil 8XXX : Wire jumper
 3XXX : Resistor 6XXX : Diode

2142	A3	2146	A4	2156	A4	2202	A6	2235	B8	3125	B4	3137	A5	3143	A3	3150	A3	3156	A4	3204	A6	3207	A6	3235	B8	3241	B8	3255	A7	3258	A8	4201	B7	6141	A4	7238	B7
2143	A4	2150	A3	2157	A4	2203	A6	2262	B8	3131	B3	3139	A4	3145	A3	3153	A4	3202	A6	3205	A6	3208	A6	3236	B8	3253	A7	3256	A7	3259	A8	4202	C7	6150	A3	7256	A7
2145	A3	2152	A4	2201	A6	2234	B8	2299	C9	3136	B3	3141	A3	3146	A4	3154	A4	3203	A6	3206	A6	3234	B8	3237	B8	3254	A7	3257	A7	3260	C7	6129	A4	7235	B8	7257	A7

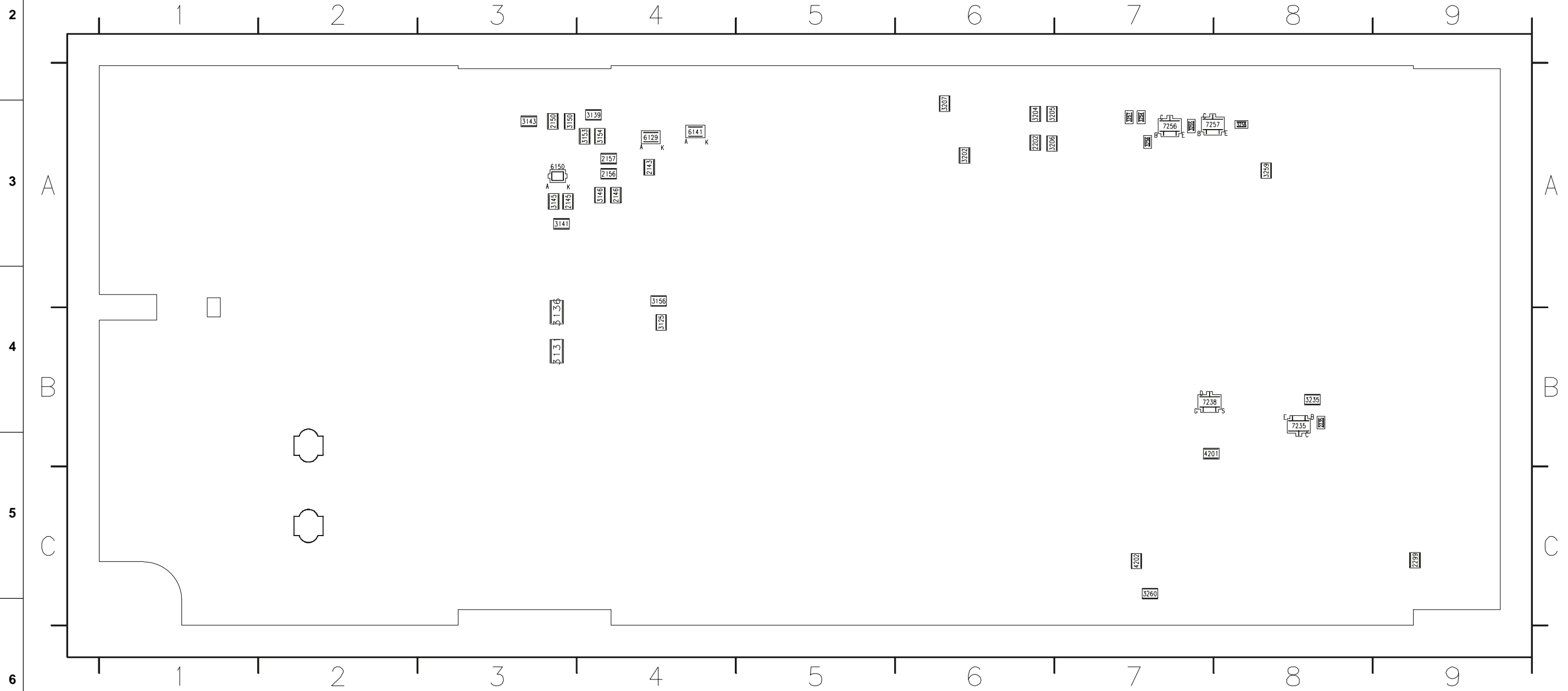

■ PRINTED CIRCUIT BOARD

STANDBY (Component side)

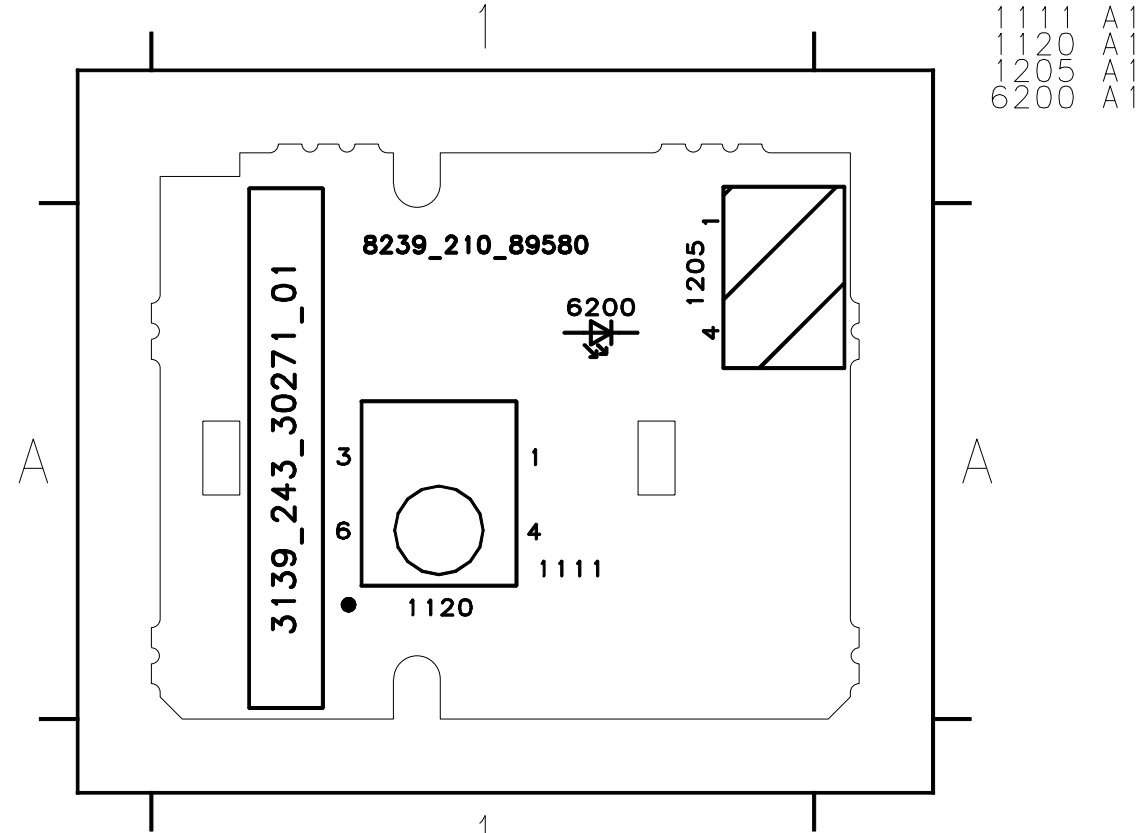

1111 A1
1120 A1
1205 A1
6200 A1

■ SCHEMATIC DIAGRAM

STANDBY

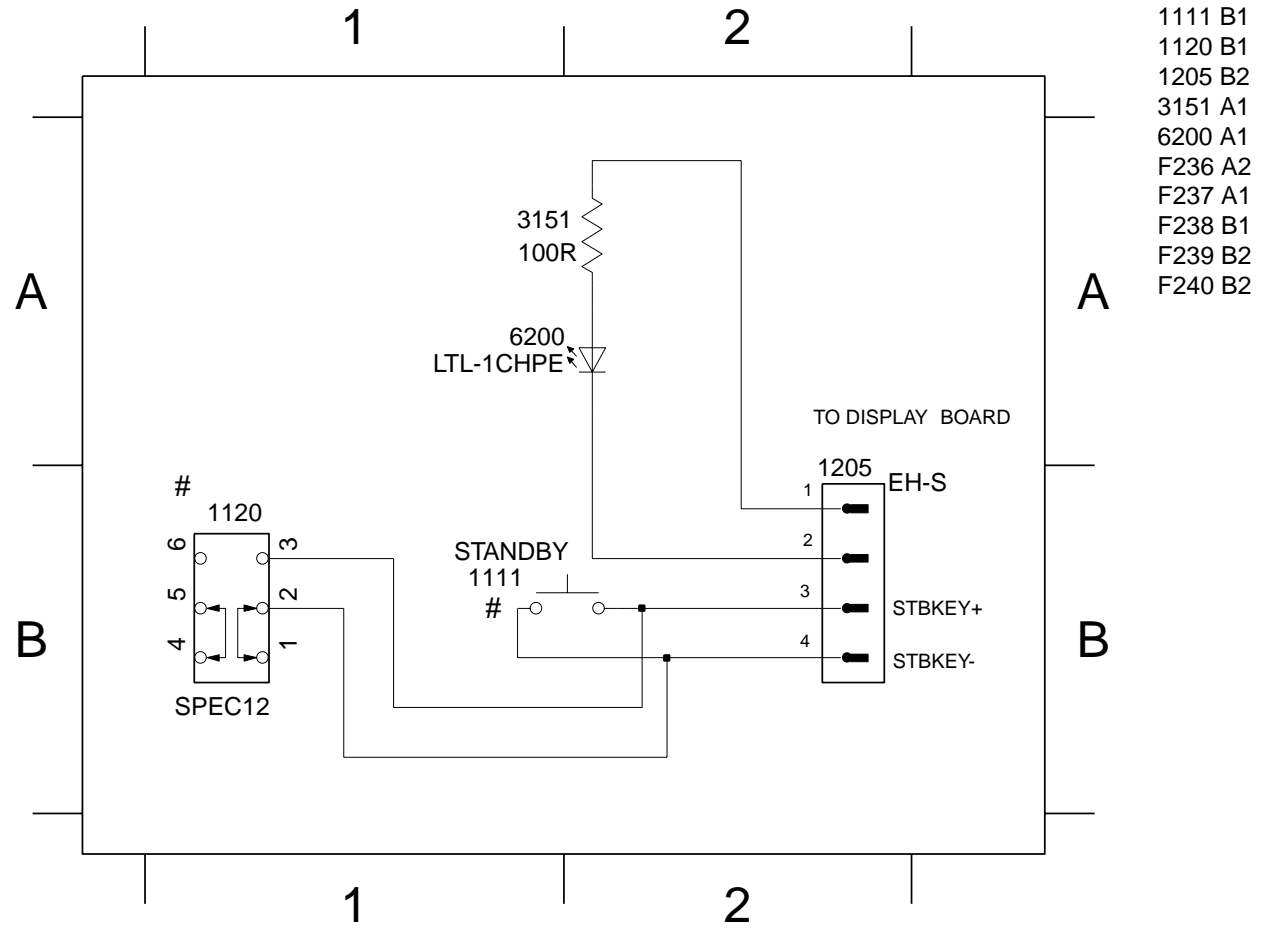

1111 B1
1120 B1
1205 B2
3151 A1
6200 A1
F236 A2
F237 A1
F238 B1
F239 B2
F240 B2

Layout Bare Board Standby (Component Side)

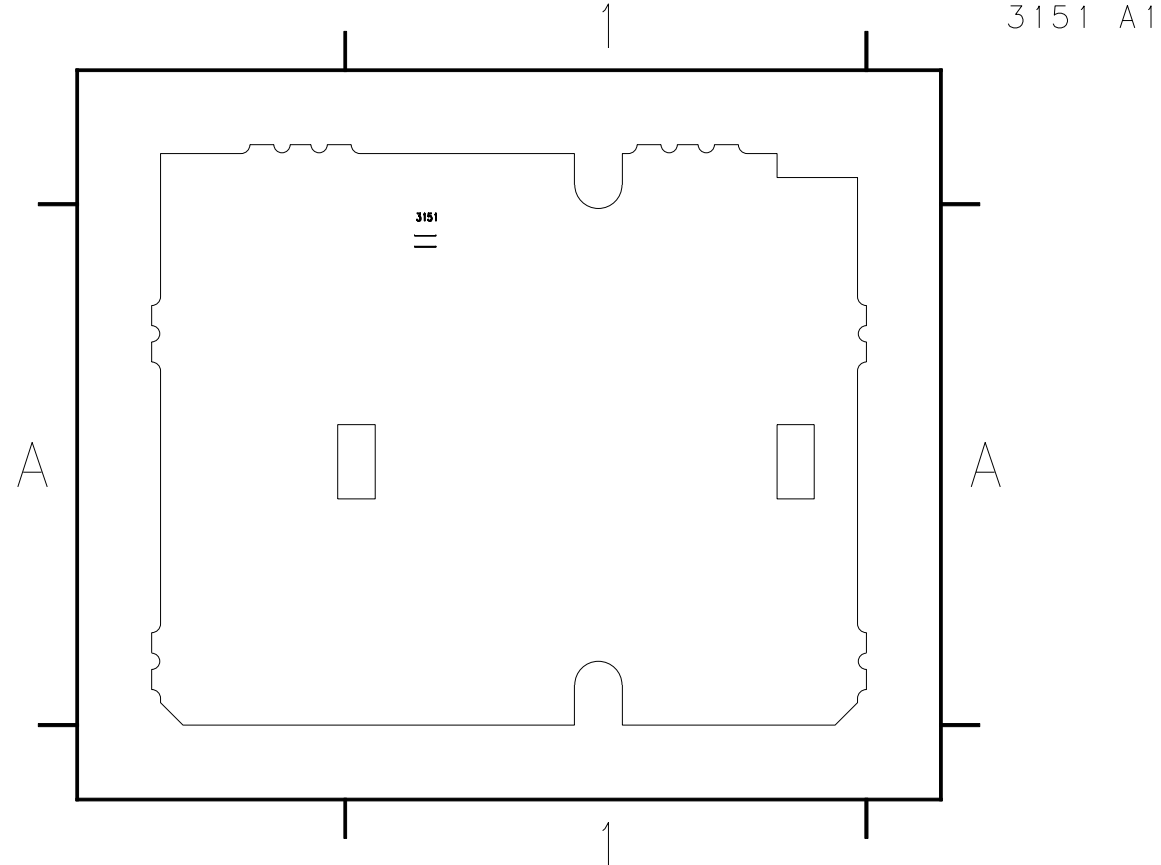

3151 A1

DIVERSITY

#	MODEL USING MECH SWITCH SW	MODEL USING TACT SWITCH SW
1120	YES	
1111		YES

The first digit of a component indicates the component type.
 1XXX : Connector 4XXX : SMD jumper 7XXX : Transistor, FET, IC
 2XXX : Capacitor 5XXX : Coil 9XXX : Wire jumper
 3XXX : Resistor 6XXX : Diode

SCHEMATIC DIAGRAM
MONO 1/6 (SERVO DALAS)

MONO BOARD only
The second digit of a component indicates the number of the schematic diagram.
E.g. IC7503 is on the schematic diagram 5.
E.g. R3100 is on the schematic diagram 1.

The first digit of a component indicates the component type.
1XXX : Connector 4XXX : SMD jumper 7XXX : Transistor, FET, IC
2XXX : Capacitor 5XXX : Coil
3XXX : Resistor 6XXX : Diode

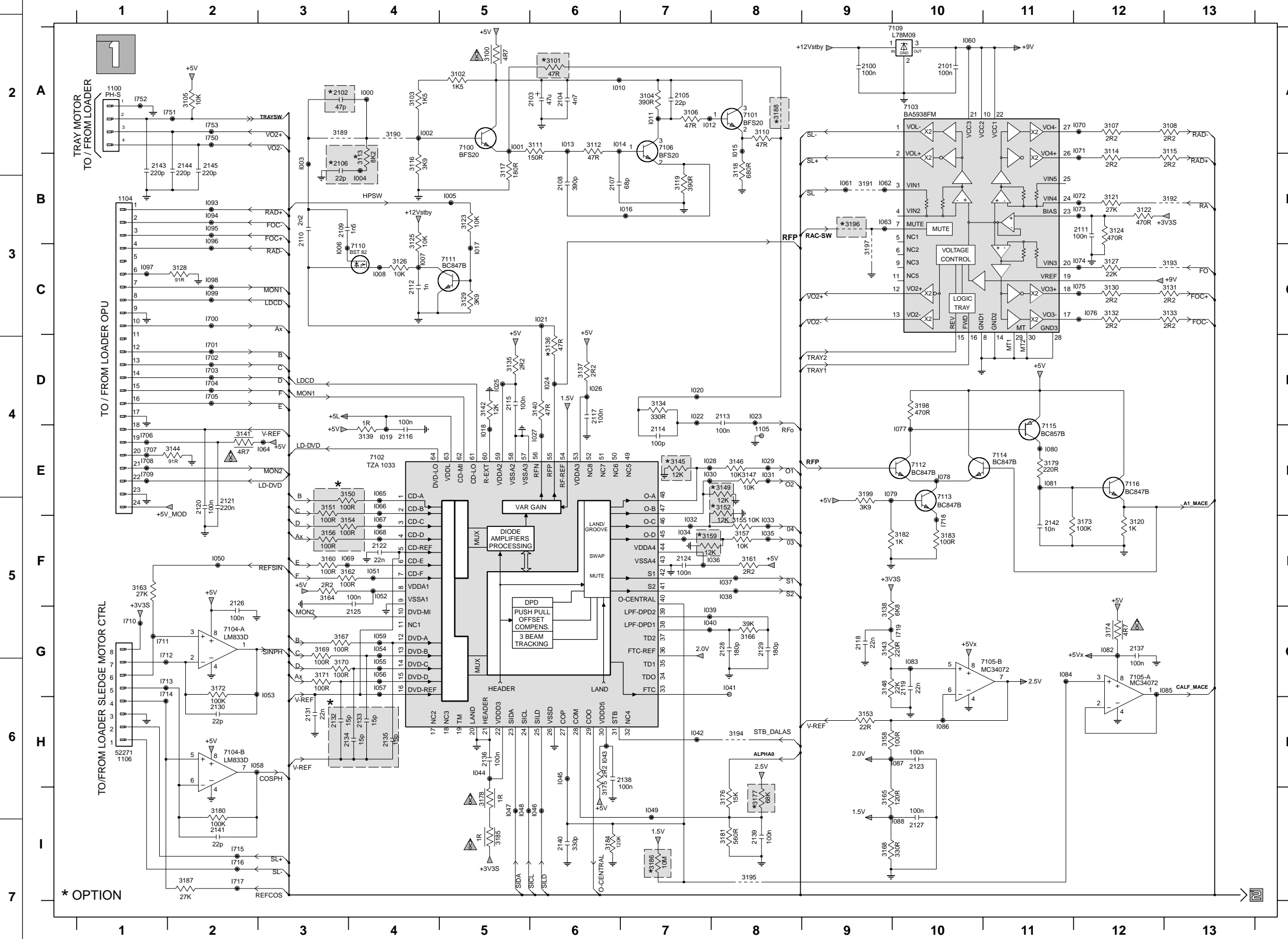

1100 A1	3168 I9	1069 F3
1104 B1	3169 G3	1070 A12
1105 E8	3170 G3	1071 A12
1106 H1	3171 G3	1072 B12
2100 A9	3172 G2	1073 B12
2101 A10	3173 F12	1074 C12
2102 A3	3174 G12	1075 C12
2103 A6	3175 I6	1076 C12
2104 A6	3176 I8	1077 E10
2105 A7	3177 I8	1078 E10
2106 B3	3178 I5	1079 E9
2107 B6	3179 E11	1080 E11
2108 B6	3180 I2	1081 E11
2109 B3	3181 I8	1082 G12
2110 B3	3182 F10	1083 G10
2111 B12	3183 F10	1084 G11
2112 C4	3184 I6	1085 G11
2113 D6	3185 I5	1086 H10
2114 E7	3186 I7	1087 H10
2115 D5	3187 I2	1088 I10
2116 E4	3188 A8	1093 B2
2117 D6	3189 A3	1094 B2
2118 G9	3190 A4	1095 B2
2119 G10	3191 B9	1096 B2
2120 E2	3192 B13	1097 C1
2121 E2	3193 C13	1098 C2
2122 F4	3194 H8	1099 C2
2123 H10	3195 I8	1700 C2
2124 F7	3196 B9	1701 D2
2125 G4	3197 C9	1702 D2
2126 F2	3198 D10	1703 D2
2127 H0	3199 E9	1704 D2
2128 G8	7100 A5	1705 D2
2129 G8	7101 A8	1706 E1
2130 H2	7102 A4	1707 E1
2131 H3	7103 A10	1708 E1
2132 H3	7104-A G2	1709 E1
2133 H4	7104-B H2	1710 G1
2134 H4	7105-A G12	1711 G1
2135 H4	7105-B G10	1712 G1
2136 H5	7106 A7	1713 G1
2137 G12	7109 A10	1714 G1
2138 H7	7110 C4	1715 I2
2139 I8	7111 C5	1716 I2
2140 I6	7112 E10	1717 I2
2141 I2	7113 E10	1718 F10
2142 E11	7114 E11	1719 G10
2143 B1	7115 D11	1750 A2
2144 B2	7116 E12	1751 A2
2145 B2	1000 A4	1752 A1
3100 A5	1001 A5	1753 A2
3101 A6	1002 A4	
3102 A5	1003 B3	
3103 A4	1004 B4	
3104 A7	1005 B5	
3105 A2	1006 C3	
3106 A7	1007 C4	
3107 A12	1008 C4	
3108 A13	1009 A6	
3110 A8	1011 A7	
3111 A6	1012 A7	
3112 A6	1013 A6	
3113 B4	1014 A6	
3114 B12	1015 A8	
3115 B13	1016 B7	
3116 B4	1017 C5	
3117 B5	1018 E5	
3118 B8	1019 E4	
3119 B7	1020 D7	
3120 F12	1021 C6	
3121 B12	1022 D7	
3122 B12	1023 D8	
3123 B5	1024 D6	
3124 B12	1025 D5	
3125 B4	1026 D6	
3126 C4	1027 E6	
3127 C12	1028 E7	
3128 C2	1029 E8	
3129 C5	1030 E7	
3130 C12	1031 E8	
3131 C13	1032 F7	
3132 C12	1033 F8	
3133 C13	1034 F7	
3134 D7	1035 F8	
3135 D5	1036 F8	
3136 D6	1037 F8	
3137 D6	1038 F8	
3138 G9	1039 G7	
3139 E4	1040 G7	
3140 D6	1041 G8	
3141 E2	1042 H7	
3142 D5	1043 H6	
3143 G9	1044 H5	
3144 E2	1045 H6	
3145 E7	1046 I6	
3146 E8	1047 I5	
3147 E8	1048 I5	
3148 G9	1049 I7	
3149 E8	1050 F2	
3150 D3	1051 F4	
3151 E3	1052 F4	
3152 E8	1053 H3	
3153 H9	1054 G4	
3154 F3	1055 G4	
3155 F8	1056 G4	
3156 F3	1057 G4	
3157 F8	1058 H2	
3158 H9	1059 G4	
3159 F7	1060 A10	
3160 F3	1061 B9	
3161 F8	1062 B9	
3162 F3	1063 B9	
3163 F1	1064 E3	
3164 F3	1065 E4	
3165 I9	1066 E4	
3166 G8	1067 F4	
3167 G3	1068 F4	

* OPTION

MONO BOARD only
The second digit of a component indicates the number of the schematic diagram.
E.g. IC7503 is on the schematic diagram 5.
E.g. R3100 is on the schematic diagram 1.

The first digit of a component indicates the component type.
1XXX : Connector 4XXX : SMD jumper 7XXX : Transistor, FET, IC
2XXX : Capacitor 5XXX : Coil 9XXX : Wire jumper
3XXX : Resistor 6XXX : Diode

SCHEMATIC DIAGRAM

MONO 2/6 (SERVO MACE)

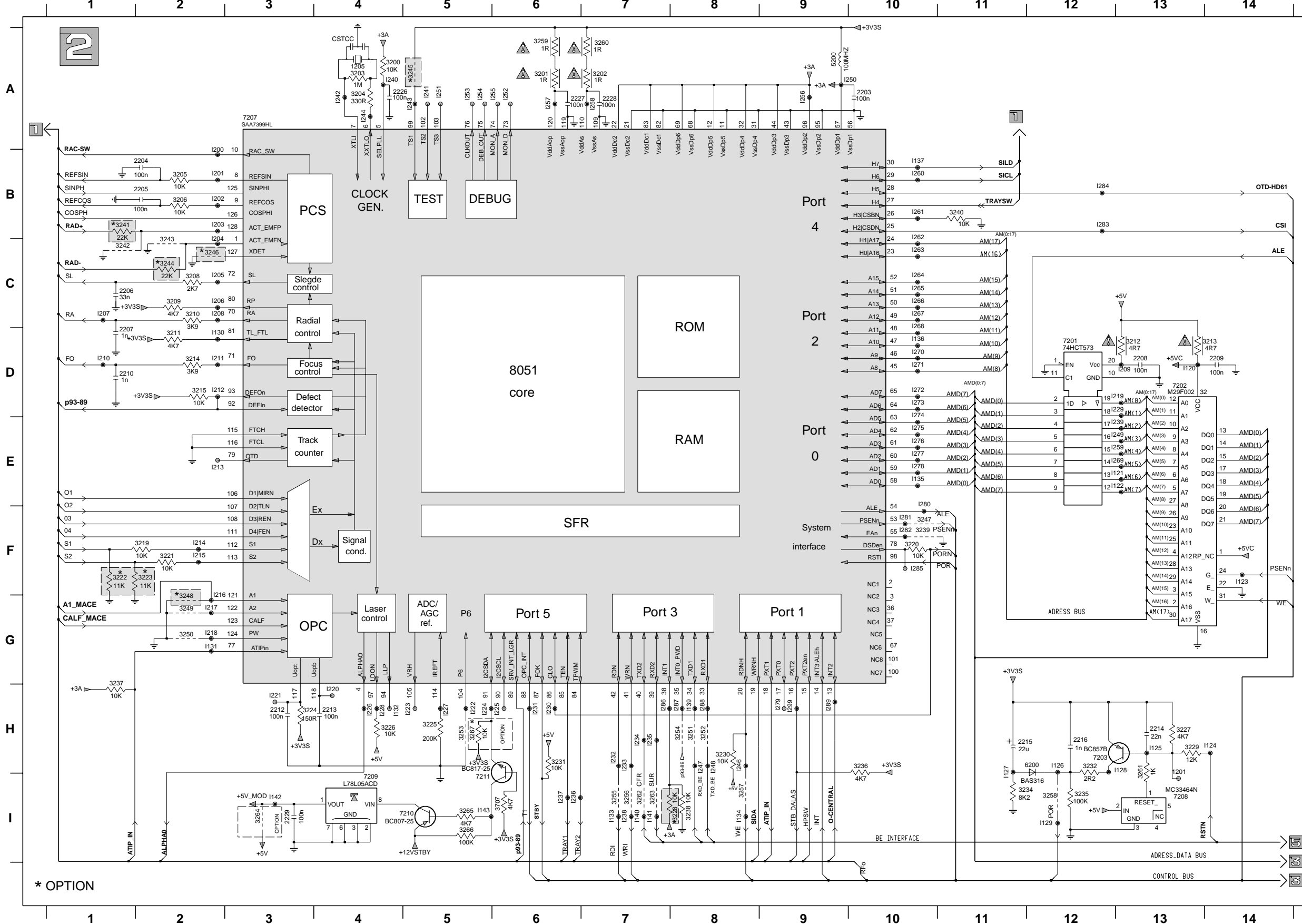

1201 H13	1203 B2
1205 A4	1204 C2
2203 A10	1205 C2
2204 B2	1206 C2
2205 B2	1207 C1
2206 C1	1208 C2
2207 D1	1209 D13
2208 D13	1210 D1
2209 D14	1211 D2
2210 D1	1212 D2
2212 H3	1213 E2
2213 H4	1214 F2
2214 H13	1215 F2
2215 H11	1216 G2
2216 H12	1217 G2
2226 A4	1218 G2
2227 A6	1219 D13
2228 A7	1220 H4
2229 I3	1221 H3
3200 A4	1222 H5
3201 A6	1223 H5
3202 A7	1224 H5
3203 A4	1225 H6
3204 A4	1226 H4
3205 B2	1227 H5
3206 B2	1228 H4
3208 C2	1229 D13
3209 C2	1230 H6
3210 C2	1231 H6
3211 D2	1232 H7
3212 D13	1233 H7
3213 D14	1234 H7
3214 D2	1235 H7
3215 D2	1236 I6
3219 F2	1237 I6
3220 F10	1238 I7
3221 F2	1239 E13
3222 F1	1240 A4
3223 F2	1241 A5
3224 H3	1242 A4
3225 H5	1243 A5
3226 H4	1244 A4
3227 H13	1246 H8
3228 I8	1247 H8
3229 H13	1248 H8
3230 H8	1249 E13
3231 H6	1250 A10
3232 H12	1251 A5
3234 I11	1252 A6
3235 I12	1253 A5
3236 H10	1254 A5
3237 H1	1255 A6
3238 I8	1256 A9
3239 F10	1257 A6
3240 B11	1258 A7
3241 B1	1259 E13
3242 C1	1260 B10
3243 C2	1261 B10
3244 C2	1262 C10
3245 A5	1263 C10
3246 C2	1264 C10
3247 F10	1265 C10
3248 G2	1266 C10
3249 G2	1267 C10
3250 G2	1268 D10
3251 H8	1269 E13
3252 H8	1270 D10
3253 H5	1271 D10
3254 H8	1272 D10
3255 I7	1273 D10
3256 I7	1274 E10
3257 I8	1275 E10
3258 I12	1276 E10
3259 A6	1277 E10
3260 A7	1278 E10
3261 H13	1279 H9
3262 I7	1280 F10
3263 I7	1281 F10
3264 I3	1282 F10
3265 I5	1283 B12
3266 I5	1284 B12
3267 H5	1285 F10
3268 I6	1286 H7
5200 A9	1287 H8
6200 H12	1288 H8
7201 D12	1289 H9
7202 D13	1290 H9
7203 H12	
7207 A3	
7208 H13	
7209 I4	
7210 I5	
7211 I5	
1120 D13	
1121 E13	
1122 E13	
1123 F14	
1124 H14	
1125 H13	
1126 H12	
1127 H11	
1128 H13	
1129 H2	
1130 D2	
1131 G2	
1132 H4	
1133 I7	
1134 I8	
1135 E10	
1136 D10	
1137 B10	
1139 H8	
1140 I7	
1141 I7	
1142 I3	
1143 I5	
1200 B2	
1201 B2	
1202 B2	

* OPTION

SCHEMATIC DIAGRAM

MONO 3/6 (Decoder)

MONO BOARD only

The second digit of a component indicates the number of the schematic diagram.

E.g. IC7503 is on the schematic diagram 5.

E.g. R3100 is on the schematic diagram 1.

The first digit of a component indicates the component type.

1XXX : Connector 4XXX : SMD jumper 7XXX : Transistor, FET, IC

2XXX : Capacitor 5XXX : Coil 9XXX : Wire jumper

3XXX : Resistor 6XXX : Diode

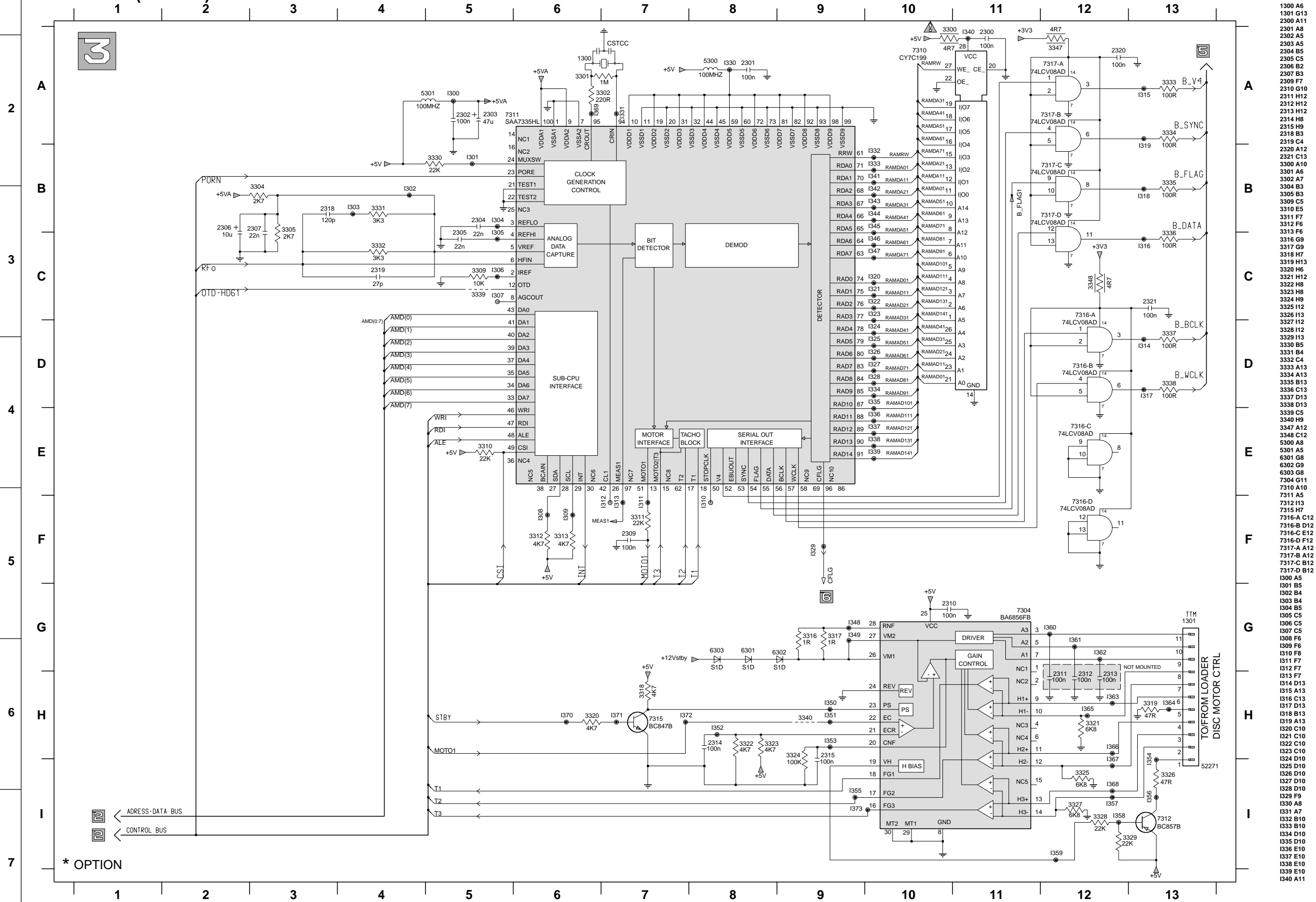

- 1300 A6
- 1301 G13
- 2300 A11
- 2301 A8
- 2302 A5
- 2303 A5
- 2304 B5
- 2305 C5
- 2306 B2
- 2307 B3
- 2309 F7
- 2310 G10
- 2311 H12
- 2312 H2
- 2313 H12
- 2314 H8
- 2315 H9
- 2316 B3
- 2317 C4
- 2319 C4
- 2320 A12
- 2321 C13
- 3000 A10
- 3001 A6
- 3002 A7
- 3004 B3
- 3005 B3
- 3009 C5
- 3010 E5
- 3011 F7
- 3012 F6
- 3013 F6
- 3016 G9
- 3017 G9
- 3018 H7
- 3019 H13
- 3020 H6
- 3021 H12
- 3022 H8
- 3023 H8
- 3025 H12
- 3026 H13
- 3027 H12
- 3028 H12
- 3029 H13
- 3030 B5
- 3031 B4
- 3032 C4
- 3033 A13
- 3034 A13
- 3035 B13
- 3036 C13
- 3037 D13
- 3038 D13
- 3039 C5
- 3040 H9
- 3047 A12
- 3048 C12
- 5000 A8
- 5001 A5
- 6001 G8
- 6002 G9
- 6003 G8
- 7004 G11
- 7010 A10
- 7011 A5
- 7012 H13
- 7015 H7
- 7316-A C12
- 7316-B D12
- 7316-C E12
- 7316-D F12
- 7317-A A12
- 7317-B A12
- 7317-C B12
- 7317-D B12
- I300 A5
- I301 B5
- I302 B4
- I303 B4
- I304 B5
- I305 C5
- I306 C5
- I307 C5
- I308 F6
- I309 F6
- I310 F8
- I311 F7
- I312 F7
- I313 F7
- I314 D13
- I315 A13
- I316 C13
- I317 D13
- I318 B13
- I319 A13
- I320 C10
- I321 C10
- I322 C10
- I323 C10
- I324 D10
- I325 D10
- I326 D10
- I327 D10
- I328 D10
- I329 F9
- I330 A8
- I331 A7
- I332 B10
- I333 B10
- I334 D10
- I335 D10
- I336 E10
- I337 E10
- I338 E10
- I339 E10
- I340 A11
- I341 B10
- I342 B10
- I343 B10
- I344 B10
- I345 B10
- I346 C10
- I347 C10
- I348 G9
- I349 G9
- I350 H9
- I351 H9
- I352 H8
- I353 H9
- I354 H13
- I355 I9
- I356 I13
- I357 I12
- I358 I12
- I359 I12
- I360 G12
- I361 G12
- I362 G12
- I363 H12
- I364 H13
- I365 H12
- I366 H12
- I367 I12
- I368 I12
- I369 A6
- I370 H6
- I371 H7
- I372 H7
- I373 I9

* OPTION

MONO BOARD only
The second digit of a component indicates the number of the schematic diagram.
E.g. IC7503 is on the schematic diagram 5.
E.g. R3100 is on the schematic diagram 1.

The first digit of a component indicates the component type.
1XXX : Connector 4XXX : SMD jumper 7XXX : Transistor, FET, IC
2XXX : Capacitor 5XXX : Coil 9XXX : Wire jumper
3XXX : Resistor 6XXX : Diode

SCHEMATIC DIAGRAM

MONO 4/6 (Memory)

4 MEMORY PART

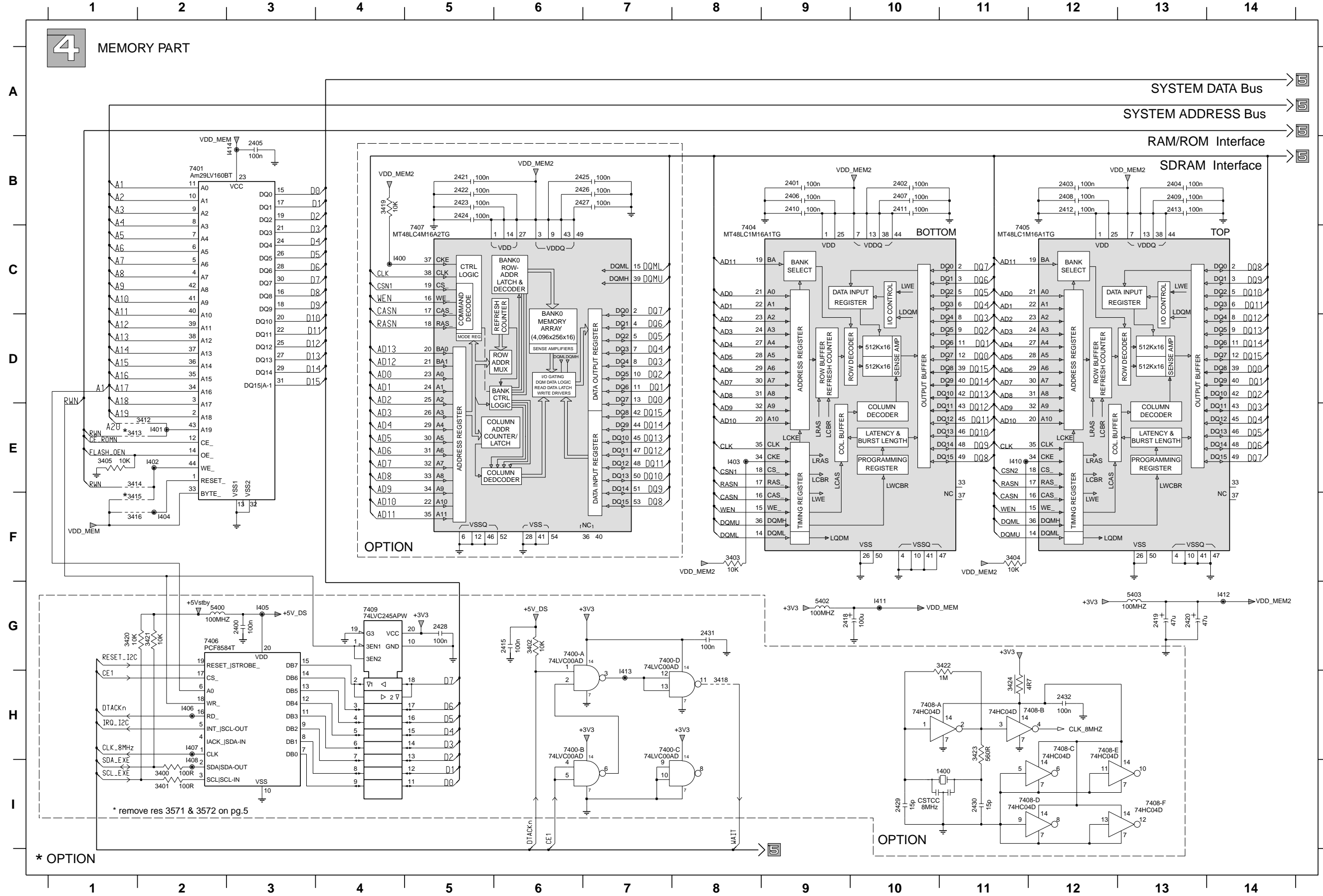

- 1400 I11
- 2400 G3
- 2401 B9
- 2402 B10
- 2403 B12
- 2404 B13
- 2405 B3
- 2406 B9
- 2407 B10
- 2408 B12
- 2409 B13
- 2410 B9
- 2411 B10
- 2412 B12
- 2413 B13
- 2415 G6
- 2418 G9
- 2419 G13
- 2420 G13
- 2421 B5
- 2422 B5
- 2423 B5
- 2424 B5
- 2425 B6
- 2426 B6
- 2427 B6
- 2428 G5
- 2429 I10
- 2430 I11
- 2431 G8
- 2432 H12
- 3400 I2
- 3401 I2
- 3402 G6
- 3403 F8
- 3404 E11
- 3405 F1
- 3412 E2
- 3413 E1
- 3414 E1
- 3415 F1
- 3416 F1
- 3418 H9
- 3419 B4
- 3420 G1
- 3421 G2
- 3422 G11
- 3423 H11
- 3424 H11
- 5400 G2
- 5402 G9
- 5403 G13
- 7400-A G6
- 7400-B H6
- 7400-C H7
- 7400-D G7
- 7401 B2
- 7404 C8
- 7405 C12
- 7406 G2
- 7407 C5
- 7408-A H10
- 7408-B H11
- 7408-C H12
- 7408-D I11
- 7408-E H12
- 7408-F I13
- 7409 G4
- I400 C4
- I401 E2
- I402 E2
- I403 E8
- I404 F2
- I405 G3
- I406 H2
- I407 H2
- I408 I2
- I410 E11
- I411 G10
- I412 G14
- I413 H7
- I414 B3

MONO BOARD only
 The second digit of a component indicates the number of the schematic diagram.
 E.g. IC7503 is on the schematic diagram 5.
 E.g. R3100 is on the schematic diagram 1.

The first digit of a component indicates the component type.
 1XXX : Connector 4XXX : SMD jumper 7XXX : Transistor, FET, IC
 2XXX : Capacitor 5XXX : Coil 9XXX : Wire jumper
 3XXX : Resistor 6XXX : Diode

SCHEMATIC DIAGRAM
MONO 5/6 (STI 5508)

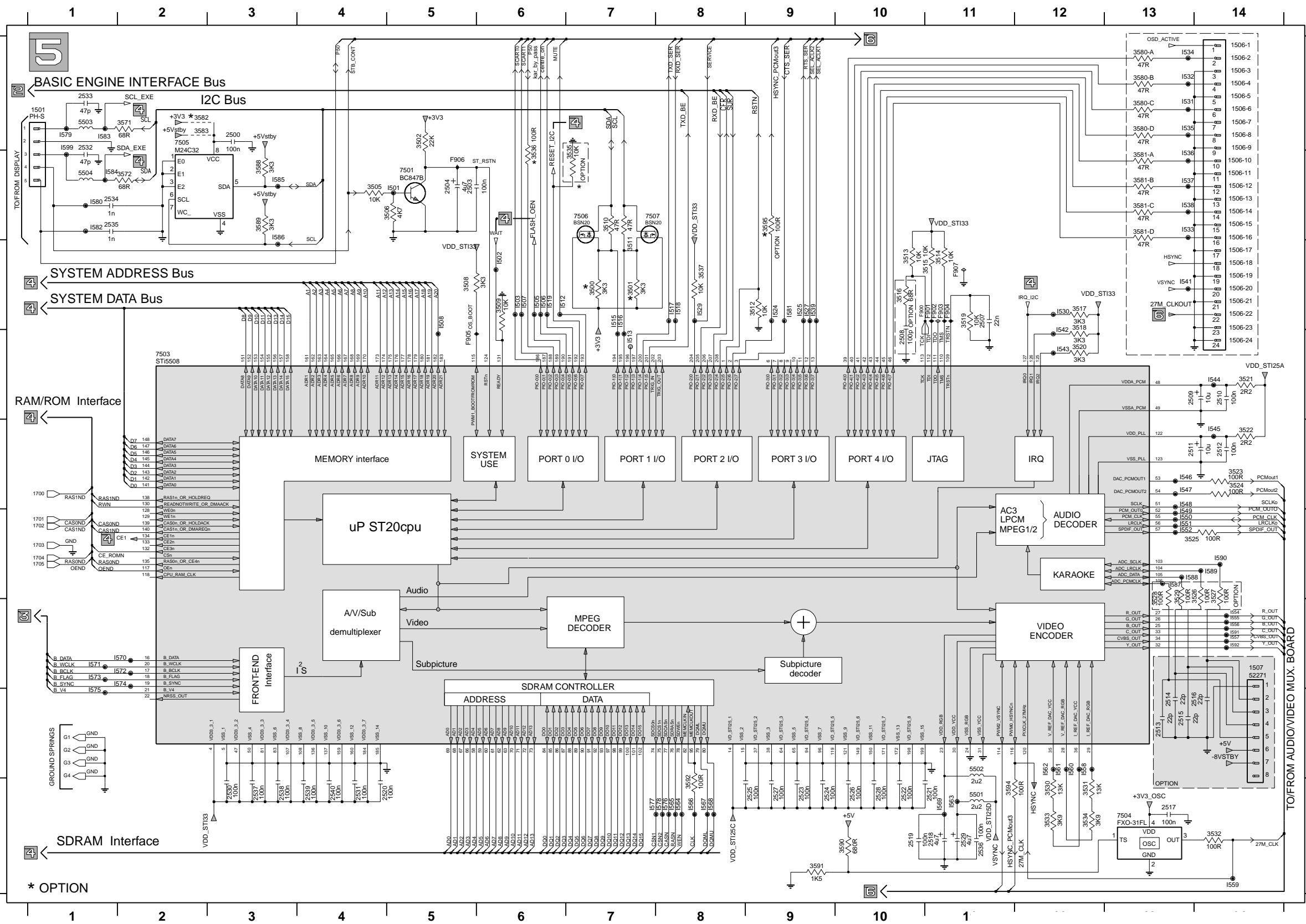

- G1 H1 3581-C B13
- G2 H1 3581-D B13
- G3 H1 3582 A2
- G4 H1 3583 A2
- I501 A1 3588 B3
- I501 A1 3589 B3
- I501 H10 3590 H10
- I501 H1 3591 I9
- I501 H1 3592 I8
- I501 H1 3594 I11
- I501 H1 3595 B9
- I501 H1 5501 H11
- I501 H1 5502 H11
- I501 H1 5503 A1
- I501 H1 5504 B1
- I501 H1 5505 A1
- I501 H1 5506 B1
- I501 H1 5507 D2
- I501 H1 5508 D2
- I501 H1 5509 D2
- I501 H1 5510 D2
- I501 H1 5511 D2
- I501 H1 5512 D2
- I501 H1 5513 D2
- I501 H1 5514 D2
- I501 H1 5515 D2
- I501 H1 5516 D2
- I501 H1 5517 D2
- I501 H1 5518 D2
- I501 H1 5519 D2
- I501 H1 5520 D2
- I501 H1 5521 D2
- I501 H1 5522 D2
- I501 H1 5523 D2
- I501 H1 5524 D2
- I501 H1 5525 D2
- I501 H1 5526 D2
- I501 H1 5527 D2
- I501 H1 5528 D2
- I501 H1 5529 D2
- I501 H1 5530 D2
- I501 H1 5531 D2
- I501 H1 5532 D2
- I501 H1 5533 D2
- I501 H1 5534 D2
- I501 H1 5535 D2
- I501 H1 5536 D2
- I501 H1 5537 D2
- I501 H1 5538 D2
- I501 H1 5539 D2
- I501 H1 5540 D2
- I501 H1 5541 D2
- I501 H1 5542 D2
- I501 H1 5543 D2
- I501 H1 5544 D2
- I501 H1 5545 D2
- I501 H1 5546 D2
- I501 H1 5547 D2
- I501 H1 5548 D2
- I501 H1 5549 D2
- I501 H1 5550 D2
- I501 H1 5551 D2
- I501 H1 5552 D2
- I501 H1 5553 D2
- I501 H1 5554 D2
- I501 H1 5555 D2
- I501 H1 5556 D2
- I501 H1 5557 D2
- I501 H1 5558 D2
- I501 H1 5559 D2
- I501 H1 5560 D2
- I501 H1 5561 D2
- I501 H1 5562 D2
- I501 H1 5563 D2
- I501 H1 5564 D2
- I501 H1 5565 D2
- I501 H1 5566 D2
- I501 H1 5567 D2
- I501 H1 5568 D2
- I501 H1 5569 D2
- I501 H1 5570 D2
- I501 H1 5571 D2
- I501 H1 5572 D2
- I501 H1 5573 D2
- I501 H1 5574 D2
- I501 H1 5575 D2
- I501 H1 5576 D2
- I501 H1 5577 D2
- I501 H1 5578 D2
- I501 H1 5579 D2
- I501 H1 5580 D2
- I501 H1 5581 D2
- I501 H1 5582 D2
- I501 H1 5583 D2
- I501 H1 5584 D2
- I501 H1 5585 D2
- I501 H1 5586 D2
- I501 H1 5587 D2
- I501 H1 5588 D2
- I501 H1 5589 D2
- I501 H1 5590 D2
- I501 H1 5591 D2
- I501 H1 5592 D2
- I501 H1 5593 D2
- I501 H1 5594 D2
- I501 H1 5595 D2
- I501 H1 5596 D2
- I501 H1 5597 D2
- I501 H1 5598 D2
- I501 H1 5599 D2

Project	Loc. 7503	Remarks	Digital YUV Option	Karaoke Option	PLL_CLK chip Option	PLL Rework Issue
SD3.0	Sti5508/Cut 1.6	Replace 5505	Insert Conn 1506 & R-pk 3580/1	Insert Conn 1507, res 3526-9 & caps 2513-6	As is	Remove 3521; replace 2510 w. jumper
SD3.0	Sti5508/Cut 2.0	Replace 5505	Insert Conn 1506, R-pk 3580/1 & R3707	Insert Conn 1507, res 3526-9 & caps 2513-6	Don't Insert 7616, 5612, 3696-99, 3703, 2618 & 2646	No Rework

MONO BOARD only
The second digit of a component indicates the number of the schematic diagram.
E.g. IC7503 is on the schematic diagram 5.
E.g. R3100 is on the schematic diagram 1.

The first digit of a component indicates the component type.
1XXX : Connector 4XXX : SMD jumper 7XXX : Transistor, FET, IC
2XXX : Capacitor 5XXX : Coil 9XXX : Wire jumper
3XXX : Resistor 6XXX : Diode

SCHEMATIC DIAGRAM

MONO 6/6 (Service interface and Back-end)

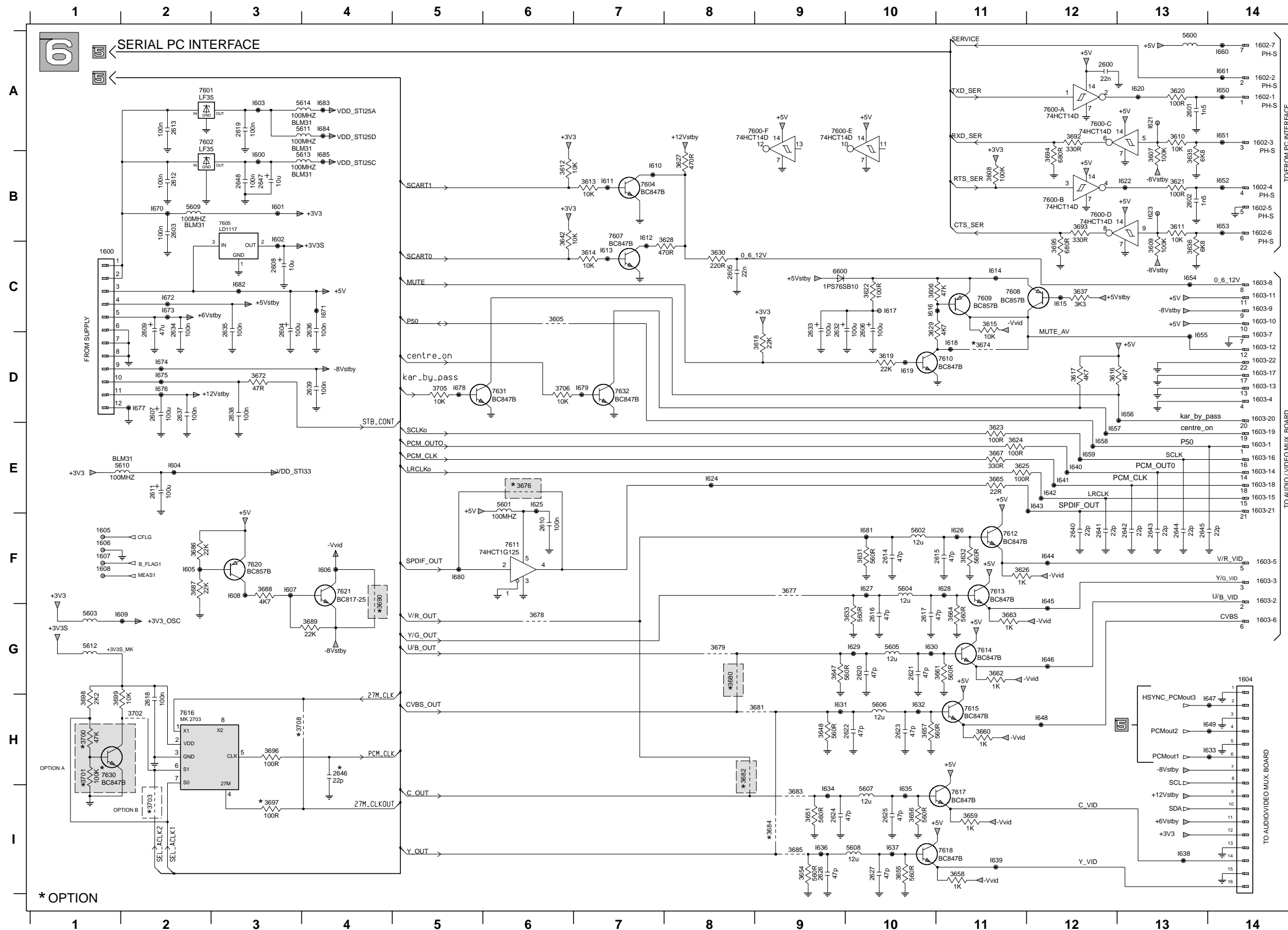

1600 C1	3654 I9	1628 F11
1602-1 A14	3655 I10	1629 G10
1602-2 A14	3656 I10	1630 G10
1602-3 A14	3657 H10	1631 H9
1602-4 B14	3658 I11	1632 H10
1602-5 B14	3659 I11	1633 H14
1602-6 B14	3660 H11	1634 I9
1602-7 A14	3661 G11	1635 I10
1603-1 E14	3662 G11	1636 I9
1603-10 C14	3663 G11	1637 I10
1603-11 C14	3664 G11	1638 I13
1603-12 D14	3665 E11	1639 I11
1603-13 D14	3667 E11	1640 E12
1603-14 E14	3672 D3	1641 E12
1603-5 B14	3674 D11	1642 E12
1603-16 E14	3676 E6	1643 E12
1603-17 D14	3677 F9	1644 F12
1603-18 E14	3678 G6	1645 F12
1603-19 E14	3679 G8	1646 G12
1603-2 F14	3680 G8	1647 H14
1603-20 D14	3681 H8	1648 H12
1603-21 E14	3682 H8	1649 H14
1603-22 D14	3683 I9	1650 A14
1603-3 F14	3684 I9	1651 A14
1603-4 D14	3685 I9	1652 B14
1603-5 F14	3686 F2	1653 B14
1603-6 G14	3687 F2	1654 C13
1603-7 D14	3688 F3	1655 D13
1603-8 C14	3689 G4	1656 D13
1603-9 C14	3690 F4	1657 E12
1604 B14	3692 A12	1658 E12
1605 F1	3693 B12	1659 E12
1606 F1	3694 B12	1660 A14
1607 F1	3695 C12	1661 A14
1608 F1	3696 H3	1670 B2
2600 A12	3697 I3	1671 C4
2601 A13	3698 H1	1672 C2
2602 B13	3699 H1	1673 C2
2603 B2	3700 H1	1674 D2
2604 C3	3701 H1	1675 D2
2605 C8	3702 H2	1676 D2
2606 C10	3703 I2	1677 D2
2607 D2	3705 D5	1678 D5
2608 C3	3706 D6	1679 D7
2609 C2	3708 H3	1680 F5
2610 F6	5600 A13	1681 F10
2611 E2	5601 E6	1682 C3
2612 B2	5602 F10	1683 A4
2613 A2	5603 G1	1684 A4
2614 F10	5604 F10	1685 B4
2615 F11	5605 G10	
2616 G10	5606 H10	
2617 G10	5607 I10	
2618 H2	5608 H10	
2619 A3	5609 B2	
2620 G10	5610 E2	
2621 G10	5611 A4	
2622 H10	5612 G1	
2623 H10	5613 B4	
2624 I9	5614 A4	
2625 I10	5600 C9	
2626 I9	7600-A A12	
2627 H10	7600-B B12	
2632 C9	7600-C A12	
2633 C9	7600-D B12	
2634 C2	7600-E A10	
2635 C3	7600-F A9	
2636 C4	7601 A2	
2637 D2	7602 A2	
2638 D3	7604 B7	
2639 D4	7605 B3	
2640 F12	7607 B7	
2641 F12	7608 C11	
2642 F13	7609 C11	
2643 F13	7610 D11	
2644 F13	7611 F6	
2645 F13	7612 F11	
2646 H4	7613 F11	
2647 B3	7614 G11	
2648 B3	7615 H11	
3605 C6	7616 H2	
3606 C10	7617 H1	
3607 B13	7618 H1	
3608 B11	7620 F3	
3609 C13	7621 F4	
3610 A13	7630 H1	
3611 B13	7631 D6	
3612 B6	7632 D7	
3613 B7	1600 B3	
3614 C7	1601 B3	
3615 C11	1602 B3	
3616 D12	1603 A3	
3617 D12	1604 E2	
3618 D9	1605 F2	
3619 D10	1606 F4	
3620 A13	1607 F3	
3621 B13	1608 F3	
3622 C10	1609 G2	
3623 E11	1610 B7	
3624 E11	1611 B7	
3625 E11	1612 B7	
3626 F11	1613 C7	
3627 B8	1614 C11	
3628 C8	1615 C12	
3629 C10	1616 C10	
3630 C8	1617 C10	
3631 F10	1618 D11	
3632 F11	1619 D10	
3633 G10	1620 A13	
3635 B13	1621 A13	
3636 C13	1622 B13	
3637 C12	1623 B13	
3642 B6	1624 E8	
3647 G9	1625 E9	
3648 H9	1626 F11	
3651 I9	1627 F10	

* OPTION
The components in the "Option A" block ie. x'tor 7630, res. 3700, 3701 are not required anymore. It was originally used in the Gapfiller project.

The first digit of a component indicates the component type.
 1XXX : Connector 4XXX : SMD jumper 7XXX : Transistor, FET, IC
 2XXX : Capacitor 5XXX : Coil 9XXX : Wire jumper
 3XXX : Resistor 6XXX : Diode

SCHEMATIC DIAGRAM

AV (U, C, A, R, T, P) 1/2

A1 AV_VIDEO

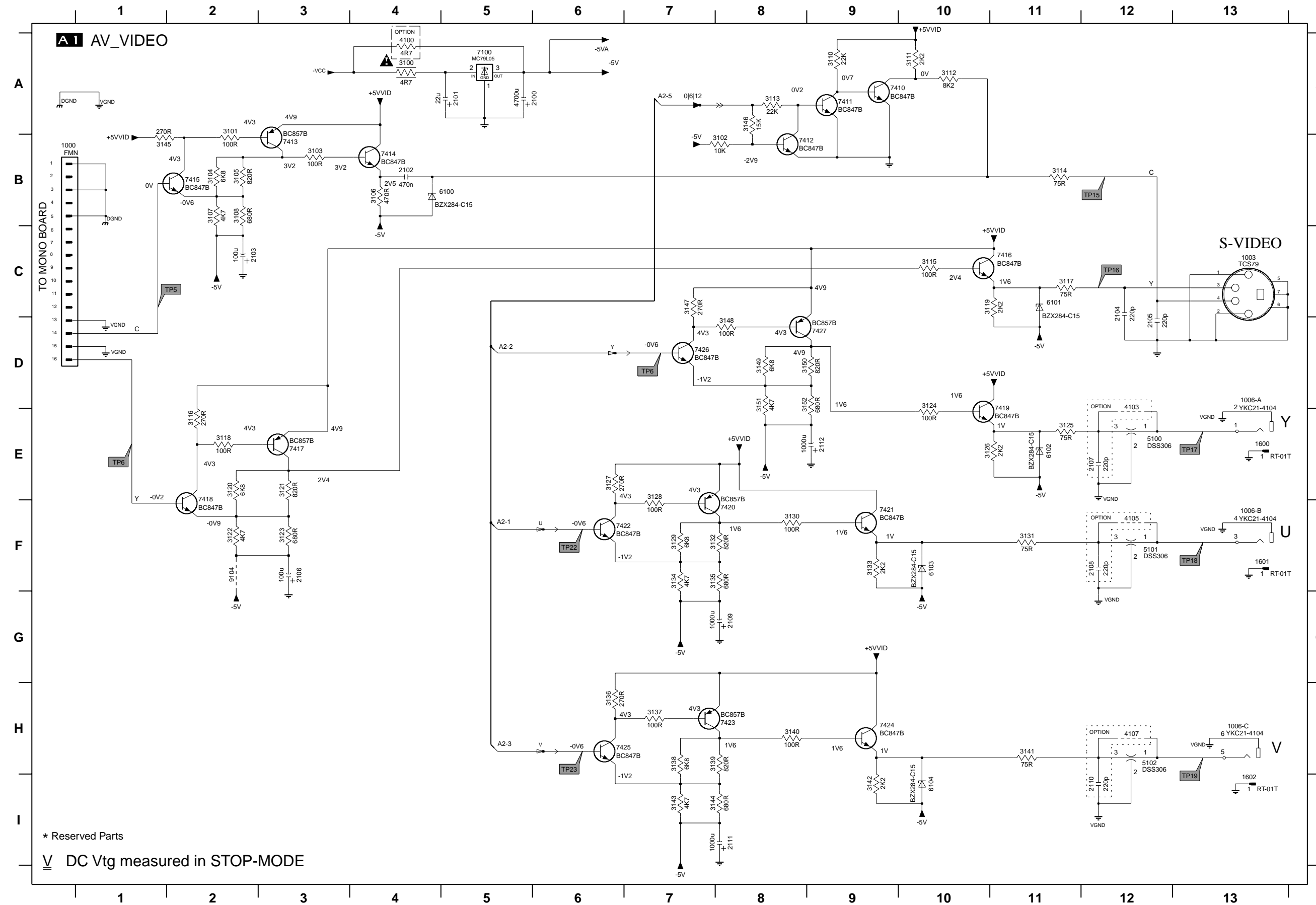

- 1000 B1
- 1003 C13
- 1006-A D13
- 1006-B F13
- 1006-C H13
- 1600 E13
- 1601 F13
- 1602 I13
- 2100 A5
- 2101 A5
- 2102 B4
- 2103 C2
- 2104 C12
- 2105 D12
- 2106 F3
- 2107 E12
- 2108 F12
- 2109 G8
- 2110 I12
- 2111 I8
- 2112 E9
- 3100 A4
- 3101 A2
- 3102 B8
- 3103 B3
- 3104 B2
- 3105 B2
- 3106 B4
- 3107 B2
- 3108 B2
- 3110 A9
- 3111 A10
- 3112 A10
- 3113 A8
- 3114 B11
- 3115 C10
- 3116 E2
- 3117 C11
- 3118 E2
- 3119 C10
- 3120 E2
- 3121 E3
- 3122 F2
- 3123 F3
- 3124 D10
- 3125 E11
- 3126 E10
- 3127 E6
- 3128 E7
- 3129 F7
- 3130 F8
- 3131 F11
- 3132 F7
- 3133 F9
- 3134 F7
- 3135 F7
- 3136 H6
- 3137 H7
- 3138 H7
- 3139 H7
- 3140 H8
- 3141 H11
- 3142 I9
- 3143 I7
- 3144 I7
- 3145 B1
- 3146 A8
- 3147 C7
- 3148 D8
- 3149 D8
- 3150 D8
- 3151 D8
- 3152 D8
- 3153 A6
- 3154 A6
- 4100 A4
- 4103 E12
- 4105 F12
- 4107 H12
- 5100 E12
- 5101 F12
- 5102 H12
- 6100 B5
- 6101 C11
- 6102 E11
- 6103 F10
- 6104 I10
- 7100 A5
- 7410 A9
- 7411 A9
- 7412 B8
- 7413 B3
- 7414 B4
- 7415 B2
- 7416 C11
- 7417 E3
- 7418 F2
- 7419 E11
- 7420 F8
- 7421 F9
- 7422 F6
- 7423 H8
- 7424 H9
- 7425 H6
- 7426 D7
- 7427 D9
- 9104 F2

* Reserved Parts

V DC Vtg measured in STOP-MODE

SCHEMATIC DIAGRAM

AV (U, C, A, R, T, P) 2/2

The first digit of a component indicates the component type.
 1XXX : Connector 4XXX : SMD jumper 7XXX : Transistor, FET, IC
 2XXX : Capacitor 5XXX : Coil 9XXX : Wire jumper
 3XXX : Resistor 6XXX : Diode

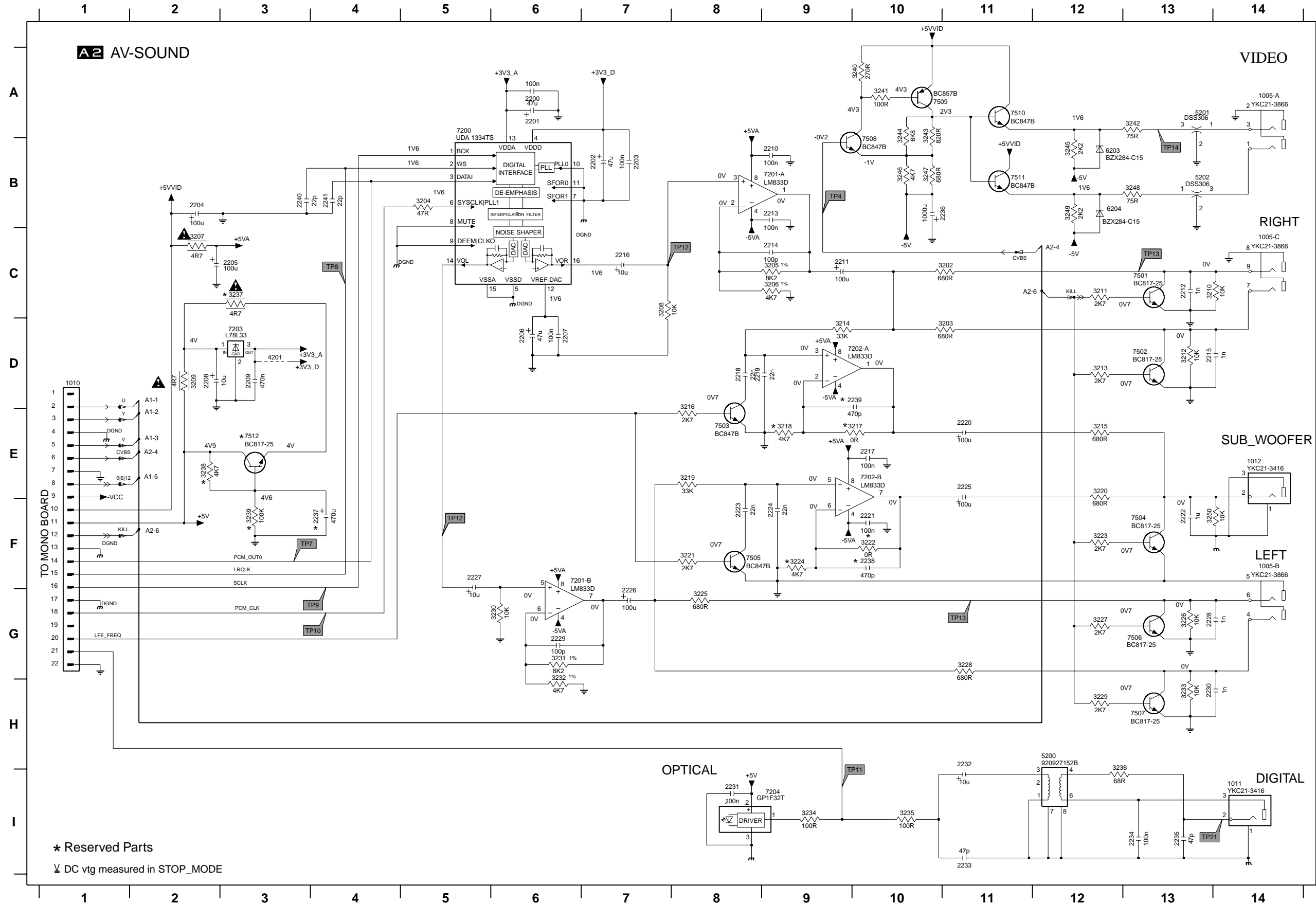

- 1005-A A14
- 1005-B F14
- 1005-C C14
- 1010 D1
- 1011 I14
- 1012 E14
- 2200 A6
- 2201 A6
- 2202 B7
- 2203 B7
- 2204 B2
- 2205 C3
- 2206 D6
- 2207 D6
- 2208 D2
- 2209 D3
- 2210 B9
- 2211 C9
- 2212 C13
- 2213 B9
- 2214 C9
- 2215 D13
- 2216 C7
- 2217 E10
- 2218 D8
- 2219 D8
- 2220 E11
- 2221 F10
- 2222 F13
- 2223 F8
- 2224 F9
- 2225 E11
- 2226 G7
- 2227 F5
- 2228 G13
- 2229 G6
- 2230 H13
- 2231 I8
- 2232 H11
- 2233 I11
- 2234 I13
- 2235 I13
- 2236 B10
- 2237 F4
- 2238 F10
- 2239 D10
- 2240 B3
- 2241 B4
- 3202 C11
- 3203 D11
- 3204 B5
- 3205 C9
- 3206 C9
- 3207 C2
- 3208 C7
- 3209 D2
- 3210 C13
- 3211 C12
- 3212 D13
- 3213 D12
- 3214 D9
- 3215 E12
- 3216 E8
- 3217 E10
- 3218 E9
- 3219 E8
- 3220 E12
- 3221 F8
- 3222 F10
- 3223 F12
- 3224 F9
- 3225 G8
- 3226 G13
- 3227 G12
- 3228 G11
- 3229 H12
- 3230 G6
- 3231 G6
- 3232 H6
- 3233 H13
- 3234 I9
- 3235 I10
- 3236 I12
- 3237 C3
- 3238 E2
- 3239 F3
- 3240 A10
- 3241 A10
- 3242 A13
- 3243 A10
- 3244 A10
- 3245 B12
- 3246 B10
- 3247 B10
- 3248 B13
- 3249 B12
- 3250 F13
- 4201 D3
- 5200 H12
- 5201 A13
- 5202 B13
- 6203 B12
- 6204 B12
- 7200 A5
- 7201-A B9
- 7201-B F6
- 7202-A D9
- 7202-B E10
- 7203 D3
- 7204 I9
- 7501 C13
- 7502 D13
- 7503 E8
- 7504 F13
- 7505 F8
- 7506 G13
- 7507 H13
- 7508 B10
- 7509 A10
- 7510 A11
- 7511 B11
- 7512 E3

* Reserved Parts
 ∇ DC vtg measured in STOP_MODE

The first digit of a component indicates the component type.
 1XXX : Connector 4XXX : SMD jumper 7XXX : Transistor, FET, IC
 2XXX : Capacitor 5XXX : Coil 9XXX : Wire jumper
 3XXX : Resistor 6XXX : Diode

■ SCHEMATIC DIAGRAM

AV (B, G) 1/2

A1 AV_VIDEO

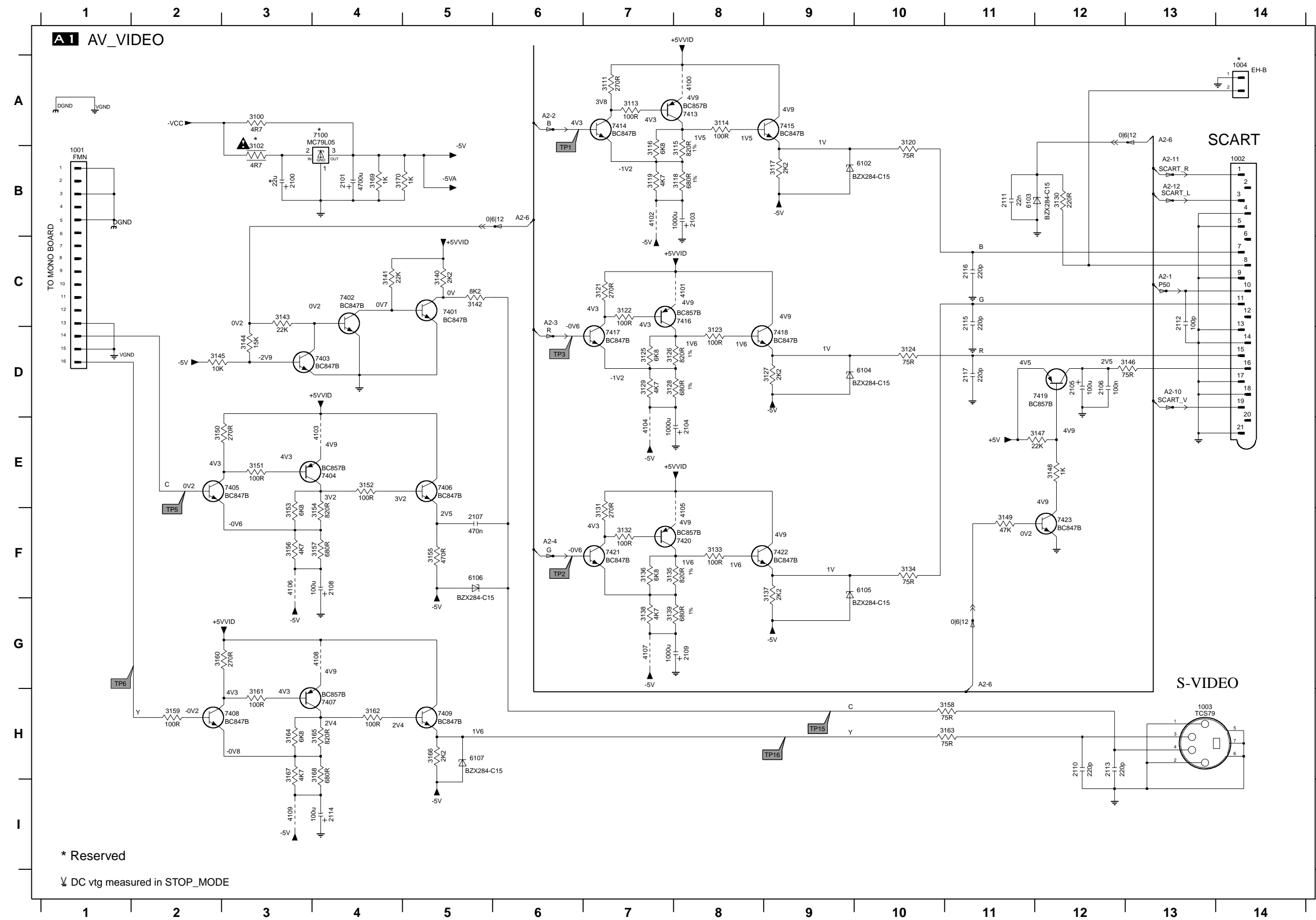

* Reserved
 √ DC vtg measured in STOP_MODE

- 1001 B1
- 1002 B4
- 1003 H13
- 1004 A14
- 2100 B3
- 2101 B4
- 2103 B8
- 2104 E8
- 2105 D12
- 2106 D12
- 2107 F5
- 2108 F4
- 2109 G8
- 2110 H12
- 2111 B11
- 2112 C13
- 2113 H12
- 2114 I4
- 2115 C11
- 2116 C11
- 2117 D11
- 3100 A3
- 3102 B3
- 3111 A7
- 3113 A7
- 3114 A8
- 3115 B8
- 3116 B7
- 3117 B9
- 3118 B8
- 3119 B7
- 3120 A10
- 3121 C7
- 3122 C7
- 3123 D8
- 3124 D10
- 3125 D7
- 3126 D7
- 3127 D9
- 3128 D7
- 3129 D7
- 3130 B12
- 3131 F7
- 3132 F7
- 3133 F8
- 3134 F10
- 3135 F7
- 3136 F7
- 3137 F9
- 3138 G7
- 3139 G7
- 3140 C5
- 3141 C4
- 3142 C5
- 3143 C3
- 3144 D3
- 3145 D2
- 3146 D13
- 3147 E12
- 3148 E12
- 3149 F11
- 3150 E2
- 3151 E3
- 3152 E4
- 3153 F3
- 3154 F4
- 3155 F5
- 3156 F3
- 3157 F4
- 3158 H11
- 3159 H2
- 3160 G2
- 3161 H3
- 3162 H4
- 3163 H11
- 3164 H3
- 3165 H4
- 3166 H5
- 3167 H3
- 3168 H4
- 3169 B4
- 3170 B4
- 4100 A8
- 4101 C8
- 4102 B7
- 4103 E4
- 4104 E7
- 4105 F8
- 4106 F3
- 4107 G7
- 4108 G4
- 4109 I3
- 6102 B10
- 6103 B11
- 6104 D10
- 6105 F10
- 6106 F5
- 6107 H5
- 7100 A4
- 7401 C5
- 7402 C4
- 7403 D4
- 7404 E4
- 7405 E3
- 7406 E5
- 7407 H4
- 7408 H3
- 7409 H5
- 7413 A8
- 7414 A7
- 7415 A9
- 7416 C8
- 7417 D7
- 7418 D9
- 7419 D11
- 7420 F8
- 7421 F7
- 7422 F9
- 7423 F12

SCHEMATIC DIAGRAM

AV (B, G) 2/2

The first digit of a component indicates the component type.
 1XXX : Connector 4XXX : SMD jumper 7XXX : Transistor, FET, IC
 2XXX : Capacitor 5XXX : Coil 9XXX : Wire jumper
 3XXX : Resistor 6XXX : Diode

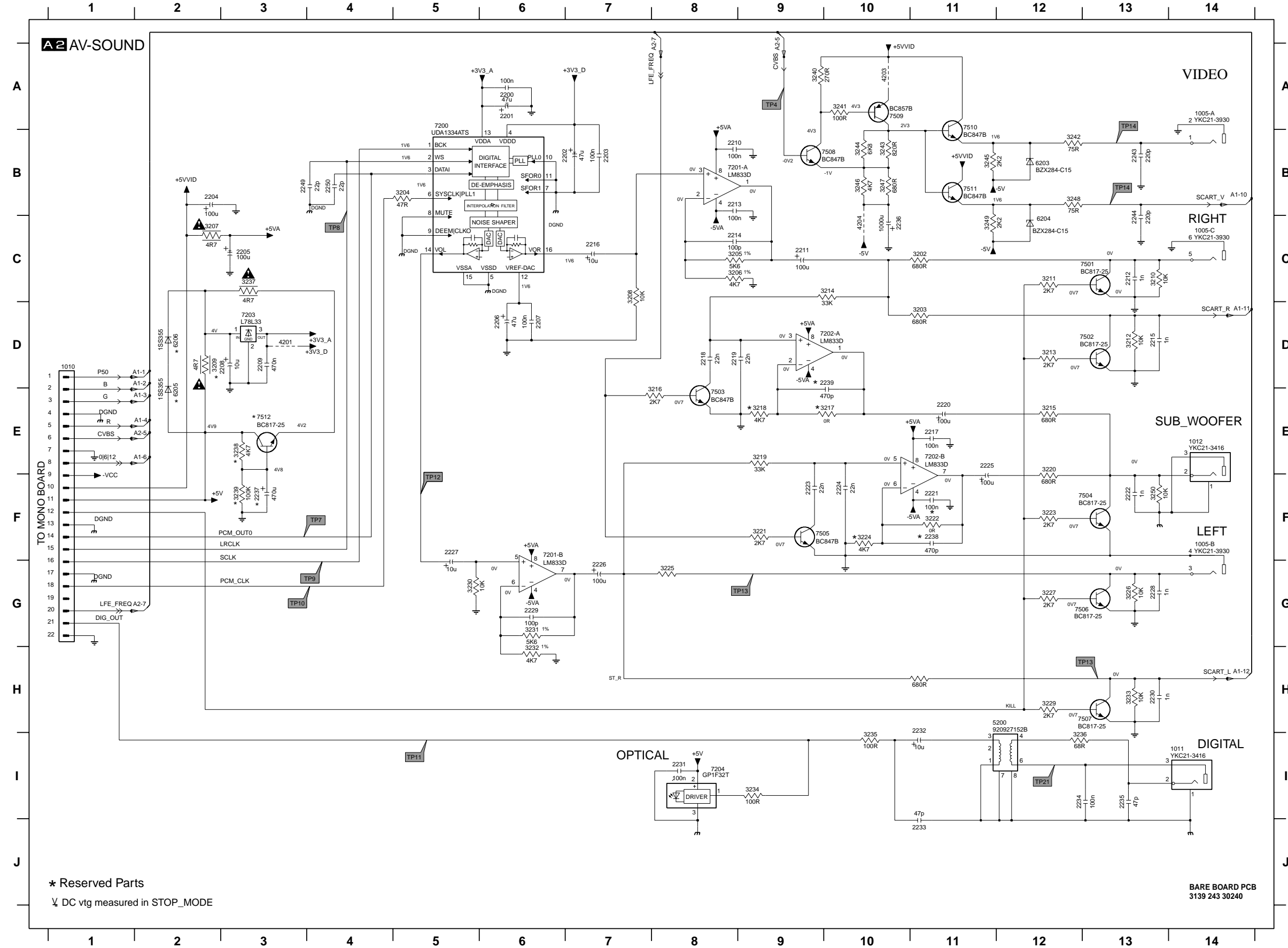

- 1005-A A14
- 1005-B F14
- 1005-C C14
- 1010 D1
- 1011 H4
- 1012 E14
- 1013 B1
- 2200 A6
- 2201 A6
- 2202 B7
- 2203 B7
- 2204 B2
- 2205 C3
- 2206 D6
- 2207 D6
- 2208 D3
- 2209 D3
- 2210 B8
- 2211 C9
- 2212 C13
- 2213 B8
- 2214 C8
- 2215 D13
- 2216 C7
- 2217 E11
- 2218 D9
- 2219 D8
- 2220 E11
- 2221 F11
- 2222 F13
- 2223 F9
- 2224 F10
- 2225 E11
- 2226 G7
- 2227 F5
- 2228 G13
- 2229 G6
- 2230 H13
- 2231 I8
- 2232 H11
- 2233 J11
- 2234 I12
- 2235 I13
- 2236 C10
- 2237 F3
- 2238 F11
- 2239 D10
- 2240 G10
- 2241 G10
- 2242 C1
- 2243 B13
- 2244 C13
- 2245 B1
- 2246 B1
- 2247 C1
- 2248 C1
- 2249 B3
- 2250 B4
- 3202 C11
- 3203 D11
- 3204 B5
- 3205 C8
- 3206 C8
- 3207 C2
- 3208 C7
- 3209 D2
- 3210 C13
- 3211 C12
- 3212 D13
- 3213 D12
- 3214 C10
- 3215 E12
- 3216 E8
- 3217 E10
- 3218 E9
- 3219 E9
- 3220 E12
- 3221 F9
- 3222 F11
- 3223 F12
- 3224 F10
- 3225 G8
- 3226 G13
- 3227 G12
- 3228 H11
- 3229 H12
- 3230 G5
- 3231 G6
- 3232 H6
- 3233 H13
- 3234 I9
- 3235 I10
- 3236 I12
- 3237 C3
- 3238 E3
- 3239 F3
- 3240 A9
- 3241 A10
- 3242 B12
- 3243 B10
- 3244 B10
- 3245 B11
- 3246 B10
- 3247 B10
- 3248 B12
- 3249 C11
- 3250 F13
- 3251 D12
- 3252 G11
- 4201 D3
- 4203 A10
- 4204 C10
- 5200 H11
- 6203 B12
- 6204 C12
- 6205 E2
- 6206 D2
- 7200 A5
- 7201-A B8
- 7201-B F6
- 7202-A D9
- 7202-B E11
- 7203 D3
- 7204 I8
- 7205-A D11

* Reserved Parts
 ∇ DC vtg measured in STOP_MODE

BARE BOARD PCB
 3139 243 30240

The first digit of a component indicates the component type.
 1XXX : Connector 4XXX : SMD jumper 7XXX : Transistor, FET, IC
 2XXX : Capacitor 5XXX : Coil 9XXX : Wire jumper
 3XXX : Resistor 6XXX : Diode

SCHEMATIC DIAGRAM

DISPLAY

DISPLAY PANEL

DC vtg measured in STOP-MODE

Diversity table for all items no marked with #

ITEM	Model using Mech SW (U, C, A, R, T, P)	Model using Tact SW (G, B)
1115	6P conn	4P conn
3155	--	Jumper
3156	--	Jumper
3157	Jumper	--
3158	Jumper	--

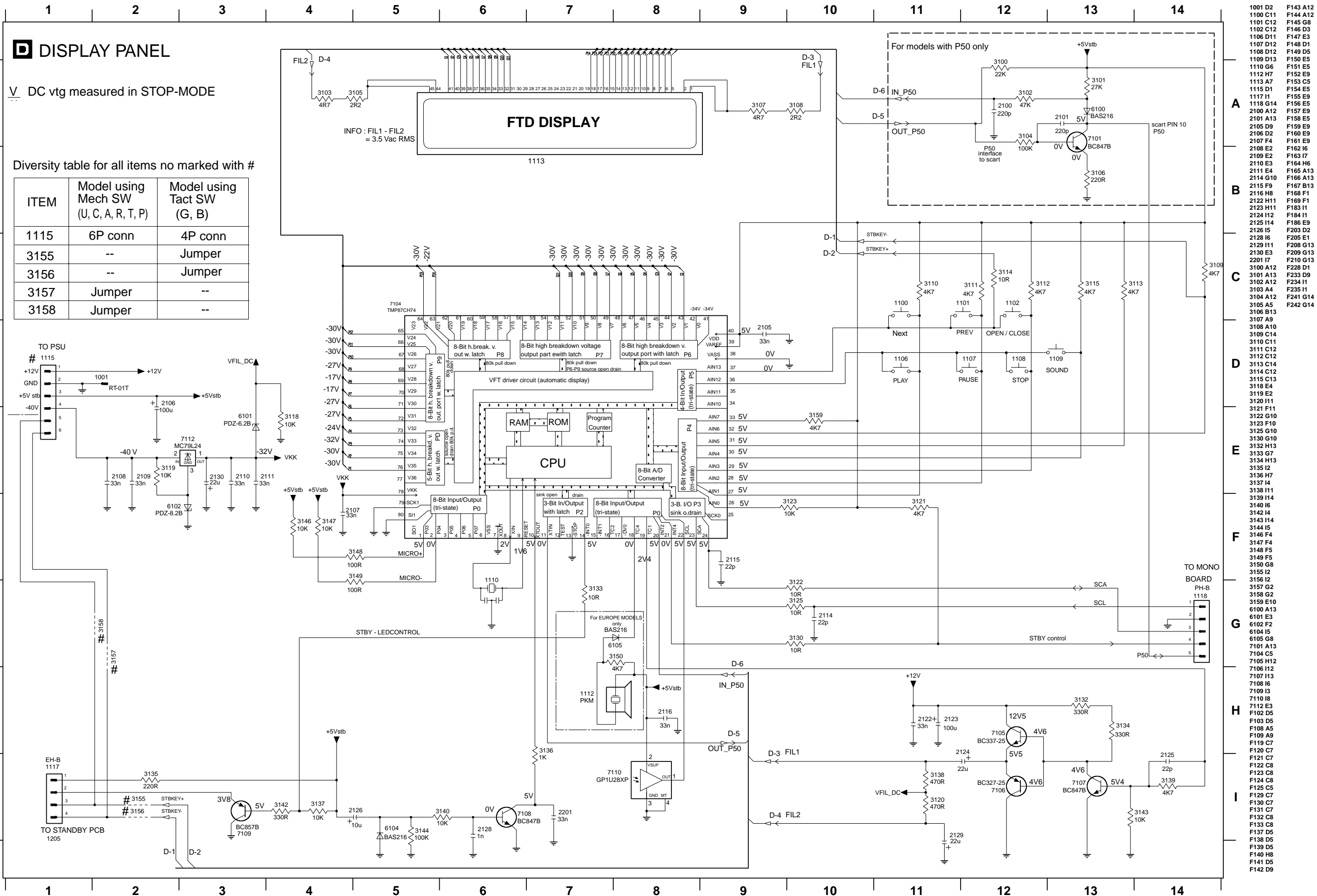

- 1001 D2
- 1100 C11
- 1101 C12
- 1102 C12
- 1106 D11
- 1107 D12
- 1108 D12
- 1109 D13
- 1110 G6
- 1112 H7
- 1113 A7
- 1115 D1
- 1117 I1
- 1118 G14
- 2100 A12
- 2101 A13
- 2105 D9
- 2106 D2
- 2107 F4
- 2108 E2
- 2109 E2
- 2110 E3
- 2111 E4
- 2114 G10
- 2116 H8
- 2122 H11
- 2123 H11
- 2124 I12
- 2125 I14
- 2126 I5
- 2128 I6
- 2129 I11
- 2130 E3
- 2201 I7
- 3100 A12
- 3101 A13
- 3102 A12
- 3103 A4
- 3104 A12
- 3105 A5
- 3106 B13
- 3107 A9
- 3108 A10
- 3109 C14
- 3110 C11
- 3111 C12
- 3112 C12
- 3113 C14
- 3114 C12
- 3115 C13
- 3118 E4
- 3119 E2
- 3120 I11
- 3121 F11
- 3122 G10
- 3123 F10
- 3125 G10
- 3130 G10
- 3132 H13
- 3133 G7
- 3134 H13
- 3135 I2
- 3136 H7
- 3137 I4
- 3138 I11
- 3139 I14
- 3140 I6
- 3142 I4
- 3143 I14
- 3144 I5
- 3146 F4
- 3147 F4
- 3148 F5
- 3149 F5
- 3150 G8
- 3155 I2
- 3156 I2
- 3157 G2
- 3158 G2
- 3159 E10
- 6100 A13
- 6101 E3
- 6102 F2
- 6104 I5
- 6105 G8
- 7101 A13
- 7104 C5
- 7105 H12
- 7106 I12
- 7107 I13
- 7108 I6
- 7109 I3
- 7110 I8
- 7112 E3
- 7102 D5
- 7103 D5
- 7108 A5
- 7109 A9
- 7119 C7
- 7120 C7
- 7121 C7
- 7122 C8
- 7123 C8
- 7124 C8
- 7125 C5
- 7129 C7
- 7130 C7
- 7131 C7
- 7132 C8
- 7133 C8
- 7137 D5
- 7138 D5
- 7139 D5
- 7140 H8
- 7141 D5
- 7142 D9
- F143 A12
- F144 A12
- F145 G8
- F146 D3
- F147 E3
- F148 D1
- F149 D5
- F150 E5
- F151 E5
- F152 E9
- F153 C5
- F154 E5
- F155 E9
- F156 E5
- F157 E9
- F158 E5
- F159 E9
- F160 E9
- F161 E9
- F162 I6
- F163 I7
- F164 H6
- F165 A13
- F167 B13
- F168 F1
- F169 F1
- F183 I1
- F184 I1
- F186 E9
- F203 D2
- F205 E1
- F208 G13
- F209 G13
- F210 G13
- F228 D1
- F233 D9
- F234 I1
- F235 I1
- F241 G14
- F242 G14

SCHEMATIC DIAGRAM

POWER (B, G)

The first digit of a component indicates the component type.
1XXX : Connector 4XXX : SMD jumper 7XXX : Transistor, FET, IC
2XXX : Capacitor 5XXX : Coil 9XXX : Wire jumper
3XXX : Resistor 6XXX : Diode

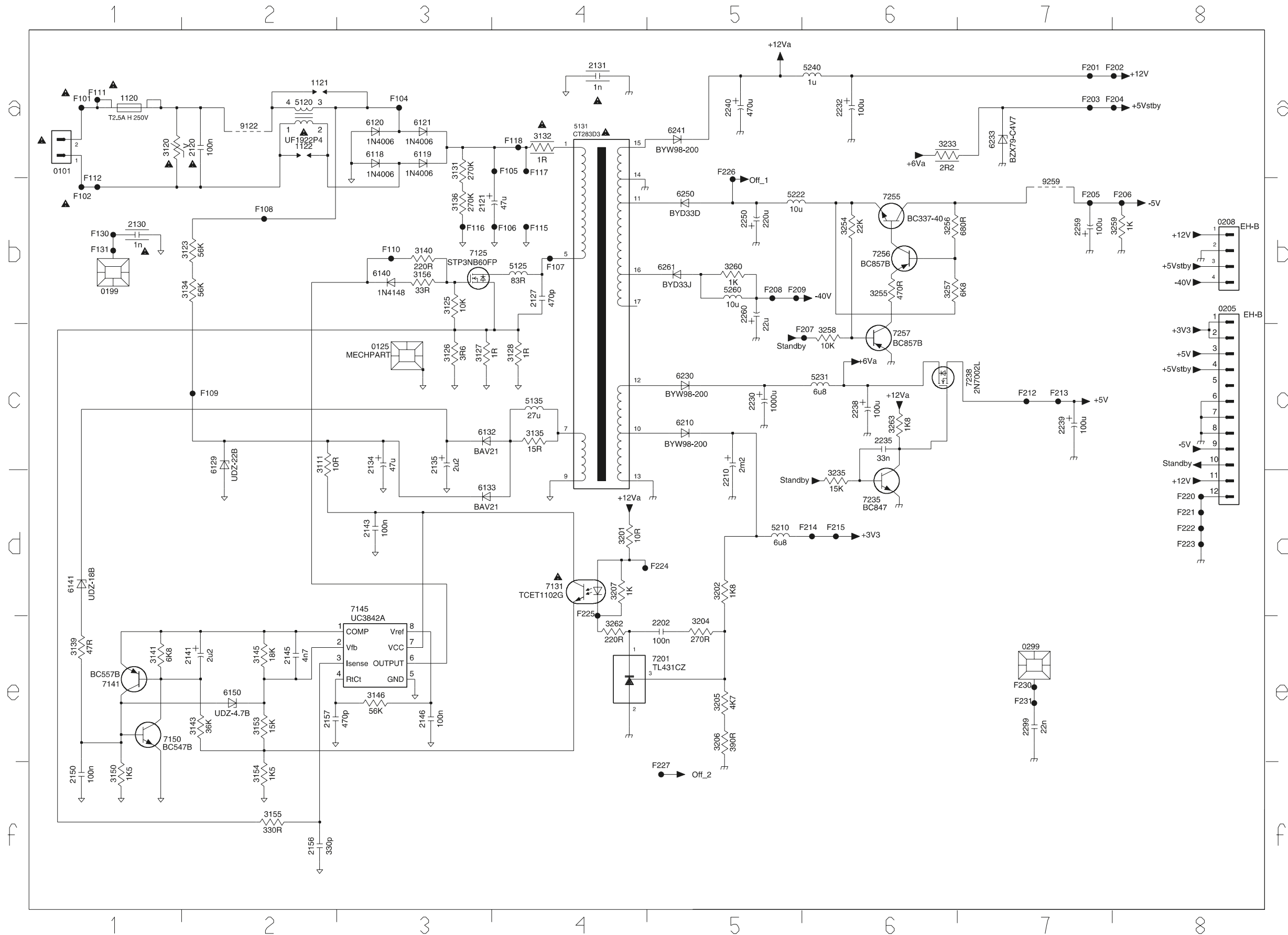

PARTS LIST

■ ELECTRICAL PARTS

■ WARNING

Components having special characteristics are marked \triangle and must be replaced with parts having specifications equal to those originally installed.

- For the parts No. of the chip carbon resistors, refer to last page of ELECTRICAL PARTS LIST.

ABBREVIATIONS IN THIS LIST ARE AS FOLLOWS:

C.A.EL.CHP	: CHIP ALUMI.ELECTROLYTIC CAP	L.EMIT	: LIGHT EMITTING MODULE
C.CE	: CERAMIC CAP	LED.DSPLY	: LED DISPLAY
C.CE.ARRAY	: CERAMIC CAP ARRAY	LED.INFRD	: LED,INFRARED
C.CE.CHP	: CHIP CERAMIC CAP	MODUL.RF	: MODULATOR,RF
C.CE.ML	: MULTILAYER CERAMIC CAP	PHOT.CPL	: PHOTO COUPLER
C.CE.M.CHP	: CHIP MULTILAYER CERAMIC CAP	PHOT.INTR	: PHOTO INTERRUPTER
C.CE.SAFTY	: RECOGNIZED CERAMIC CAP	PHOT.RFLCT	: PHOTO REFLECTOR
C.CE.TUBLR	: CERAMIC TUBULAR CAP	PIN.TEST	: PIN,TEST POINT
C.CE.SMI	: SEMI CONDUCTIVE CERAMIC CAP	PLST.RIVET	: PLASTIC RIVET
C.EL	: ELECTROLYTIC CAP	R.ARRAY	: RESISTOR ARRAY
C.MICA	: MICA CAP	R.CAR.	: CARBON RESISTOR
C.ML.FLM	: MULTILAYER FILM CAP	R.CAR.CHP	: CHIP RESISTOR
C.MP	: METALLIZED PAPER CAP	R.CAR.FP	: FLAME PROOF CARBON RESISTOR
C.MYLAR	: MYLAR FILM CAP	R.FUS	: FUSABLE RESISTOR
C.MYLAR.ML	: MULTILAYER MYLAR FILM CAP	R.MTL.CHP	: CHIP METAL FILM RESISTOR
C.PAPER	: PAPER CAPACITOR	R.MTL.FLM	: METAL FILM RESISTOR
C.PLS	: POLYSTYRENE FILM CAP	R.MTL.OXD	: METAL OXIDE FILM RESISTOR
C.POL	: POLYESTER FILM CAP	R.MTL.PLAT	: METAL PLATE RESISTOR
C.POLY	: POLYETHYLENE FILM CAP	RSNR.CE	: CERAMIC RESONATOR
C.PP	: POLYPROPYLENE FILM CAP	RSNR.CRYS	: CRYSTAL RESONATOR
C.TNTL	: TANTALUM CAP	R.TW.CEM	: TWIN CEMENT FIXED RESISTOR
C.TNTL.CHP	: CHIP TANTALUM CAP	R.WW	: WIRE WOUND RESISTOR
C.TRIM	: TRIMMER CAP	SCR.BND.HD	: BIND HEAD B-TITE SCREW
CN	: CONNECTOR	SCR.BW.HD	: BW HEAD TAPPING SCREW
CN.BS.PIN	: CONNECTOR,BASE PIN	SCR.CUP	: CUP TITE SCREW
CN.CANNON	: CONNECTOR,CANNON	SCR.TERM	: SCREW TERMINAL
CN.DIN	: CONNECTOR,DIN	SCR.TR	: SCREW,TRANSISTOR
CN.FLAT	: CONNECTOR,FLAT CABLE	SUPRT.PCB	: SUPPORT,P.C.B.
CN.POST	: CONNECTOR,BASE POST	SURG.PRTCT	: SURGE PROTECTOR
COIL.MX.AM	: COIL,AM MIX	SW.TACT	: TACT SWITCH
COIL.AT.FM	: COIL,FM ANTENNA	SW.LEAF	: LEAF SWITCH
COIL.DT.FM	: COIL,FM DETECT	SW.LEVER	: LEVER SWITCH
COIL.MX.FM	: COIL,FM MIX	SW.MICRO	: MICRO SWITCH
COIL.OUTPT	: OUTPUT COIL	SW.PUSH	: PUSH SWITCH
DIOD.ARRAY	: DIODE ARRAY	SW.RT.ENC	: ROTARY ENCODER
DIODE.BRG	: DIODE BRIDGE	SW.RT.MTR	: ROTARY SWITCH WITH MOTOR
DIODE.CHP	: CHIP DIODE	SW.RT	: ROTARY SWITCH
DIODE.VAR	: VARACTOR DIODE	SW.SLIDE	: SLIDE SWITCH
DIOD.Z.CHP	: CHIP ZENER DIODE	TERM.SP	: SPEAKER TERMINAL
DIODE.ZENR	: ZENER DIODE	TERM.WRAP	: WRAPPING TERMINAL
DSCR.CE	: CERAMIC DISCRIMINATOR	THRMST.CHP	: CHIP THERMISTOR
FER.BEAD	: FERRITE BEADS	TR.CHP	: CHIP TRANSISTOR
FER.CORE	: FERRITE CORE	TR.DGT	: DIGITAL TRANSISTOR
FET.CHP	: CHIP FET	TR.DGT.CHP	: CHIP DIGITAL TRANSISTOR
FL.DSPLY	: FLUORESCENT DISPLAY	TRANS	: TRANSFORMER
FLTR.CE	: CERAMIC FILTER	TRANS.PULS	: PULSE TRANSFORMER
FLTR.COMB	: COMB FILTER MODULE	TRANS.PWR	: POWER TRANSFORMER ASS'Y
FLTR.LC.RF	: LC FILTER,EMI	TUNER.AM	: TUNER PACK,AM
GND.MTL	: GROUND PLATE	TUNER.FM	: TUNER PACK,FM
GND.TERM	: GROUND TERMINAL	TUNER.PK	: FRONT-END TUNER PACK
HOLDER.FUS	: FUSE HOLDER	VR	: ROTARY POTENTIOMETER
IC.PRTCT	: IC PROTECTOR	VR.MTR	: POTENTIOMETER WITH MOTOR
JUMPER.CN	: JUMPER CONNECTOR	VR.SW	: POTENTIOMETER WITH ROTARY SW
JUMPER.TST	: JUMPER,TEST POINT	VR.SLIDE	: SLIDE POTENTIOMETER
L.DTCT	: LIGHT DETECTING MODULE	VR.TRIM	: TRIMMER POTENTIOMETER

Note) Those parts marked with “#” are not included in the P.C.B. ass'y.

P. C. B. MONO

*
*

Schm Ref.	PART NO.	Description	Remarks
	AAAX29590	P. C. B.	MONO (UCARTP)
	AAAX29600	P. C. B.	MONO (GB)
1104	AAAX22180	CON	BMH 24P FFC
1106	AAAX22190	CON	BMH 8P FFC
1205	AAAX23320	RSNR. CRYST	8.467MHz
1300	AAAX23310	RSNR. CRYST	6MHz
1301	AAAX22360	CON	11P FEMALE
1603	AAAX22210	CON	BMV 22P FFC
1604	AAAX22200	CON	BMV 16P FFC
2100	US135100	C. CE. CHP	0.1uF 16V
2101	US135100	C. CE. CHP	0.1uF 16V
2103	UF037470	C. EL. CHP	47uF 16V
2104	US063470	C. CE. CHP	4700pF 50V
2105	US061220	C. CE. CHP	22pF 50V
2107	US061680	C. CE. CHP	68PF 50V
2108	US062390	C. CE. CHP	390PF 50V
2109	US063150	C. CE. M. CHP	1500pF 50V
2110	US063220	C. CE. CHP	2200pF 50V
2111	US135100	C. CE. CHP	0.1uF 16V
2112	US063100	C. CE. CHP	1000pF 50V
2113	US135100	C. CE. CHP	0.1uF 16V
2114	US062100	C. CE. CHP	100pF 50V
2115	US135100	C. CE. CHP	0.1uF 16V
2116	US135100	C. CE. CHP	0.1uF 16V
2117	US135100	C. CE. CHP	0.1uF 16V
2118	US044220	C. CE. CHP	0.022uF 25V
2119	US044220	C. CE. CHP	0.022uF 25V
2120	US135100	C. CE. CHP	0.1uF 16V
2121	US135220	C. CE. CHP	0.22uF 16V
2122	US044220	C. CE. CHP	0.022uF 25V
2123	US135100	C. CE. CHP	0.1uF 16V
2124	US135100	C. CE. CHP	0.1uF 16V
2125	US135100	C. CE. CHP	0.1uF 16V
2126	US135100	C. CE. CHP	0.1uF 16V
2127	US135100	C. CE. CHP	0.1uF 16V
2128	US062180	C. CE. CHP	180pF 50V
2129	US062180	C. CE. CHP	180pF 50V
2130	US061220	C. CE. CHP	22pF 50V
2131	US044220	C. CE. CHP	0.022uF 25V
2136	US135100	C. CE. CHP	0.1uF 16V
2137	US135100	C. CE. CHP	0.1uF 16V
2138	US135100	C. CE. CHP	0.1uF 16V
2139	US135100	C. CE. CHP	0.1uF 16V
2140	US062330	C. CE. CHP	330P 50V
2141	US061220	C. CE. CHP	22pF 50V
2142	US064100	C. CE. CHP	0.01uF 50V
2143	US062220	C. CE. CHP	220pF 50V
2144	US062220	C. CE. CHP	220pF 50V
2145	US062220	C. CE. CHP	220pF 50V
2203	US135100	C. CE. CHP	0.1uF 16V
2204	US135100	C. CE. CHP	0.1uF 16V
2205	US135100	C. CE. CHP	0.1uF 16V
2206	US034330	C. CE. CHP	0.033uF 16V
2207	US063100	C. CE. CHP	1000pF 50V
2208	US135100	C. CE. CHP	0.1uF 16V
2209	US135100	C. CE. CHP	0.1uF 16V
2210	US063100	C. CE. CHP	1000pF 50V
2212	US135100	C. CE. CHP	0.1uF 16V
2213	US135100	C. CE. CHP	0.1uF 16V
2214	US044220	C. CE. CHP	0.022uF 25V
2215	UF017220	C. EL. CHP	22uF 6.3V
2216	US063100	C. CE. CHP	1000pF 50V
2226	US135100	C. CE. CHP	0.1uF 16V

* New Parts

Schm Ref.	PART NO.	Description	Remarks
2227	US135100	C. CE. CHP	0.1uF 16V
2228	US135100	C. CE. CHP	0.1uF 16V
2229	US135100	C. CE. CHP	0.1uF 16V
2300	US135100	C. CE. CHP	0.1uF 16V
2301	US135100	C. CE. CHP	0.1uF 16V
2302	US135100	C. CE. CHP	0.1uF 16V
2303	UF017470	C. EL. CHP	47uF 6.3V
2304	US044220	C. CE. CHP	0.022uF 25V
2305	US044220	C. CE. CHP	0.022uF 25V
2306	UF037100	C. EL. CHP	10uF 16V
2307	US044220	C. CE. CHP	0.022uF 25V
2309	US135100	C. CE. CHP	0.1uF 16V
2310	US135100	C. CE. CHP	0.1uF 16V
2314	US135100	C. CE. CHP	0.1uF 16V
2315	US135100	C. CE. CHP	0.1uF 16V
2318	US062120	C. CE. CHP	120PF 50V
2319	US061270	C. CE. CHP	27PF 50V
2320	US135100	C. CE. CHP	0.1uF 16V
2321	US135100	C. CE. CHP	0.1uF 16V
2401	US135100	C. CE. CHP	0.1uF 16V
2402	US135100	C. CE. CHP	0.1uF 16V
2403	US135100	C. CE. CHP	0.1uF 16V
2404	US135100	C. CE. CHP	0.1uF 16V
2405	US135100	C. CE. CHP	0.1uF 16V
2406	US135100	C. CE. CHP	0.1uF 16V
2407	US135100	C. CE. CHP	0.1uF 16V
2408	US135100	C. CE. CHP	0.1uF 16V
2409	US135100	C. CE. CHP	0.1uF 16V
2410	US135100	C. CE. CHP	0.1uF 16V
2411	US135100	C. CE. CHP	0.1uF 16V
2412	US135100	C. CE. CHP	0.1uF 16V
2413	US135100	C. CE. CHP	0.1uF 16V
2418	UF038100	C. EL. CHP	100uF 16V
2419	UF017470	C. EL. CHP	47uF 6.3V
2420	UF017470	C. EL. CHP	47uF 6.3V
2500	US135100	C. CE. CHP	0.1uF 16V
2503	US135100	C. CE. CHP	0.1uF 16V
2504	UF066470	C. EL. CHP	4.7uF 50V
2507	US044220	C. CE. CHP	0.022uF 25V
2509	UF037100	C. EL. CHP	10uF 16V
2510	US135100	C. CE. CHP	0.1uF 16V
2511	UF037100	C. EL. CHP	10uF 16V
2512	US135100	C. CE. CHP	0.1uF 16V
2513	US061220	C. CE. CHP	22pF 50V
2514	US061220	C. CE. CHP	22pF 50V
2515	US061220	C. CE. CHP	22pF 50V
2516	US061220	C. CE. CHP	22pF 50V
2517	US135100	C. CE. CHP	0.1uF 16V
2518	UF066470	C. EL. CHP	4.7uF 50V
2519	US135100	C. CE. CHP	0.1uF 16V
2520	US135100	C. CE. CHP	0.1uF 16V
2521	US135100	C. CE. CHP	0.1uF 16V
2522	US135100	C. CE. CHP	0.1uF 16V
2523	US135100	C. CE. CHP	0.1uF 16V
2524	US135100	C. CE. CHP	0.1uF 16V
2525	US135100	C. CE. CHP	0.1uF 16V
2526	US135100	C. CE. CHP	0.1uF 16V
2527	US135100	C. CE. CHP	0.1uF 16V
2528	US135100	C. CE. CHP	0.1uF 16V
2529	UF066470	C. EL. CHP	4.7uF 50V
2530	US135100	C. CE. CHP	0.1uF 16V
2531	US135100	C. CE. CHP	0.1uF 16V
2532	US061470	C. CE. CHP	47pF 50V

* New Parts

DVD-S520/DV-S5450

P. C. B. MONO

Schm Ref.	PART NO.	Description	Remarks
2533	US061470	C. CE. CHP 47pF 50V	4822 122 33777
2534	US063100	C. CE. CHP 1000pF 50V	5322 126 11578
2535	US063100	C. CE. CHP 1000pF 50V	5322 126 11578
2536	US135100	C. CE. CHP 0. 1uF 16V	4822 126 14305
2537	US135100	C. CE. CHP 0. 1uF 16V	4822 126 14305
2538	US135100	C. CE. CHP 0. 1uF 16V	4822 126 14305
2539	US135100	C. CE. CHP 0. 1uF 16V	4822 126 14305
2540	US135100	C. CE. CHP 0. 1uF 16V	4822 126 14305
2600	US044220	C. CE. CHP 0. 022uF 25V	4822 126 14494
2601	US063150	C. CE. CHP 1500pF 50V	4822 126 14247
2602	US063150	C. CE. CHP 1500pF 50V	4822 126 14247
2603	US135100	C. CE. CHP 0. 1uF 16V	4822 126 14305
2604	UF038100	C. EL. CHP 100uF 16V	4822 124 12095
2605	US044220	C. CE. CHP 0. 022uF 25V	4822 126 14494
2606	UF038100	C. EL. CHP 100uF 16V	4822 124 12095
2607	UF038100	C. EL. CHP 100uF 16V	4822 124 12095
2608	UF037100	C. EL. CHP 10uF 16V	4822 124 23002
2609	UF037470	C. EL. CHP 47uF 16V	4822 124 80151
2610	US135100	C. CE. CHP 0. 1uF 16V	4822 126 14305
2611	UF038100	C. EL. CHP 100uF 16V	4822 124 12095
2614	US061470	C. CE. CHP 47pF 50V	4822 122 33777
2615	US061470	C. CE. CHP 47pF 50V	4822 122 33777
2616	US061470	C. CE. CHP 47pF 50V	4822 122 33777
2617	US061470	C. CE. CHP 47pF 50V	4822 122 33777
2618	US135100	C. CE. CHP 0. 1uF 16V	4822 126 14305
2620	US061470	C. CE. CHP 47pF 50V	4822 122 33777
2621	US061470	C. CE. CHP 47pF 50V	4822 122 33777
2622	US061470	C. CE. CHP 47pF 50V	4822 122 33777
2623	US061470	C. CE. CHP 47pF 50V	4822 122 33777
2624	US061470	C. CE. CHP 47pF 50V	4822 122 33777
2625	US061470	C. CE. CHP 47pF 50V	4822 122 33777
2626	US061470	C. CE. CHP 47pF 50V	4822 122 33777
2627	US061470	C. CE. CHP 47pF 50V	4822 122 33777
2632	UF038100	C. EL. CHP 100uF 16V	4822 124 12095
2633	UF038100	C. EL. CHP 100uF 16V	4822 124 12095
2634	US135100	C. CE. CHP 0. 1uF 16V	4822 126 14305
2635	US135100	C. CE. CHP 0. 1uF 16V	4822 126 14305
2636	US135100	C. CE. CHP 0. 1uF 16V	4822 126 14305
2637	US135100	C. CE. CHP 0. 1uF 16V	4822 126 14305
2638	US135100	C. CE. CHP 0. 1uF 16V	4822 126 14305
2639	US135100	C. CE. CHP 0. 1uF 16V	4822 126 14305
2641	US061220	C. CE. CHP 22pF 50V	4822 122 33761
2647	UF037100	C. EL. CHP 10uF 16V	4822 124 23002
2648	US135100	C. CE. CHP 0. 1uF 16V	4822 126 14305
5200	AAAX22070	COIL BLM31P500SPT	4822 157 11717
5300	AAAX22070	COIL BLM31P500SPT	4822 157 11717
5301	AAAX22070	COIL BLM31P500SPT	4822 157 11717
5402	AAAX22050	COIL BLM11P600SPT	4822 157 11499
5403	AAAX22050	COIL BLM11P600SPT	4822 157 11499
5501	AAAX22110	COIL 2. 2uH NL322522T	4822 157 70299
5502	AAAX22110	COIL 2. 2uH NL322522T	4822 157 70299
5503	AAAX22130	COIL BLM21A601SPT	4822 157 71206
5504	AAAX22130	COIL BLM21A601SPT	4822 157 71206
5600	AAAX22130	COIL BLM21A601SPT	4822 157 71206
5601	AAAX22050	COIL BLM11P600SPT	4822 157 11499
* 5602	AAAX29690	COIL 12uH	4822 157 70651
* 5603	AAAX22130	COIL BLM21A601SPT	4822 157 71206
* 5604	AAAX29690	COIL 12uH	4822 157 70651
* 5605	AAAX29690	COIL 12uH	4822 157 70651
* 5606	AAAX29690	COIL 12uH	4822 157 70651
* 5607	AAAX29690	COIL 12uH	4822 157 70651
* 5608	AAAX29690	COIL 12uH	4822 157 70651
5609	AAAX22070	COIL BLM31P500SPT	4822 157 11717

* New Parts

Schm Ref.	PART NO.	Description	Remarks
5610	AAAX22070	COIL BLM31P500SPT	4822 157 11717
5611	AAAX22070	COIL BLM31P500SPT	4822 157 11717
5612	AAAX22050	COIL BLM11P600SPT	4822 157 11499
6200	AAAX22630	DIODE. CHP BAS316	4822 130 11397
6301	AAAX22690	DIODE. CHP S1D	9322 128 69685
6302	AAAX22690	DIODE. CHP S1D	9322 128 69685
6303	AAAX22690	DIODE. CHP S1D	9322 128 69685
* 6600	AAAX29900	DIODE. CHP RB501V-40	9322 154 46685
6601	AAAX22690	DIODE. CHP S1D	9322 128 69685
7100	AAAX22750	TR. CHP BFS20	5322 130 42718
7101	AAAX22750	TR. CHP BFS20	5322 130 42718
7102	AAAX21880	IC TZA1033HL	9352 637 37518
7103	AAAX21620	IC BA5938FM	4822 209 17229
7104	AAAX21660	IC LM833D	4822 209 30095
7105	AAAX21690	IC MC34072D	4822 209 32073
7106	AAAX22750	TR. CHP BFS20	5322 130 42718
7109	AAAX21580	IC AN78M09	4822 209 15083
7110	AAAX22760	TR. CHP BST72A	5322 130 60803
7111	AAAX22740	TR. CHP BC847B	4822 130 60511
7112	AAAX22740	TR. CHP BC847B	4822 130 60511
7113	AAAX22740	TR. CHP BC847B	4822 130 60511
7114	AAAX22740	TR. CHP BC847B	4822 130 60511
7115	AAAX22730	TR. CHP BC856B	4822 130 60373
7116	AAAX22740	TR. CHP BC847B	4822 130 60511
7201	AAAX21860	IC 74HCT573	9351 869 80118
* 7202	AAAX29470	IC AM29F002T	3104 123 85860
7203	AAAX22730	TR. CHP BC856B	4822 130 60373
* 7207	AAAX29480	IC SAA7399HL	4822 209 17231
7208	AAAX21780	IC MC33464N-45A	9322 139 67685
* 7209	AAAX29490	IC L78L05ACD	4822 209 90927
* 7210	AAAX29930	TR. CHP BC807-25	5322 130 60845
7211	AAAX22780	TR. CHP BC817-25	4822 130 42804
7304	AAAX21600	IC BA6856FP	4822 209 16877
7310	AAAX21590	IC CY7C199-15C	4822 209 15899
* 7311	AAAX29530	IC SAA7335HL	9352 622 13557
7312	AAAX22730	TR. CHP BC856B	4822 130 60373
7315	AAAX22740	TR. CHP BC847B	4822 130 60511
* 7316	AAAX29520	IC 74LVC08AD	9352 500 20118
* 7317	AAAX29520	IC 74LVC08AD	9352 500 20118
7404	AAAX21800	IC MT48LC1M16A1TG-7S	9322 144 59668
7405	AAAX21800	IC MT48LC1M16A1TG-7S	9322 144 59668
7501	AAAX22740	TR. CHP BC847B	4822 130 60511
* 7503	AAAX29500	IC STI5508	9322 159 29671
* 7504	AAAX30380	RSNR. CRY5 OSC XTL SM 27MHZ	12722 171 08709
7505	AAAX21850	IC M24C32-WMN6TNKSA	9322 156 81668
* 7506	AAAX29940	TR. CHP BSN20	5322 130 63289
* 7507	AAAX29940	TR. CHP BSN20	5322 130 63289
7600	AAAX21740	IC PC74HCT14T	5322 209 71568
7604	AAAX22740	TR. CHP BC847B	4822 130 60511
7605	AAAX21630	IC LD1117DT33	4822 209 17398
7607	AAAX22740	TR. CHP BC847B	4822 130 60511
7608	AAAX22730	TR. CHP BC856B	4822 130 60373
7609	AAAX22730	TR. CHP BC856B	4822 130 60373
7610	AAAX22740	TR. CHP BC847B	4822 130 60511
* 7611	AAAX29510	IC 74HCT1G125	9352 456 80115
7612	AAAX22740	TR. CHP BC847B	4822 130 60511
7613	AAAX22740	TR. CHP BC847B	4822 130 60511
7614	AAAX22740	TR. CHP BC847B	4822 130 60511
7615	AAAX22740	TR. CHP BC847B	4822 130 60511
7616	AAAX21840	IC SM MK2703STR	9322 151 71668
7617	AAAX22740	TR. CHP BC847B	4822 130 60511
7618	AAAX22740	TR. CHP BC847B	4822 130 60511
7620	AAAX22730	TR. CHP BC856B	4822 130 60373

* New Parts

DVD-S520/DV-S5450

P. C. B. MONO & P. C. B. AV

Schm Ref.	PART NO.	Description	Remarks
7621	AAx22780	TR. CHP	BC817-25
7631	AAx22740	TR. CHP	BC847B
7632	AAx22740	TR. CHP	BC847B
*	AAx29570	P. C. B.	AV(UCARTP)
1000	AAx22220	CN	BMV 16P FFC
1003	AAx22350	JACK. DIN	4P MDIN
1005	AAx22240	JACK. PIN	6P
1006	AAx22250	JACK. PIN	3P
1010	AAx22230	CN	BMV 22P FFC
* 1011	AAx30050	JACK. PIN	2P YKC21-3416
* 1012	AAx30050	JACK. PIN	2P YKC21-3416
* 2100	UJ729470	C. EL	4700uF 10V
2102	UB445470	C. CE. M. CHP	0. 47uF 16V
2103	UR848100	C. EL	100uF 25V
2104	US062220	C. CE. CHP	220pF 50V
2105	US062220	C. CE. CHP	220pF 50V
2106	UR848100	C. EL	100uF 25V
2109	UR819100	C. EL	1000uF 6. 3V
2111	UR819100	C. EL	1000uF 6. 3V
2112	UR819100	C. EL	1000uF 6. 3V
2200	US135100	C. CE. CHP	0. 1uF 16V
2201	UR837470	C. EL	47uF 16V
2202	UR837470	C. EL	47uF 16V
2203	US135100	C. CE. CHP	0. 1uF 16V
2204	UR848100	C. EL	100uF 25V
2205	UR828100	C. EL	100uF 10V
2206	UR837470	C. EL	47uF 16V
2207	US135100	C. CE. CHP	0. 1uF 16V
2208	UR837100	C. EL	10uF 16V
2209	UB445470	C. CE. M. CHP	0. 47uF 16V
2210	US135100	C. CE. CHP	0. 1uF 16V
2211	UR828100	C. EL	100uF 10V
2212	US063100	C. CE. M. CHP	1000pF 50V
2213	US135100	C. CE. CHP	0. 1uF 16V
2214	US062100	C. CE. CHP	100pF 50V
2215	US063100	C. CE. M. CHP	1000pF 50V
2216	UR837100	C. EL	10uF 16V
2217	US135100	C. CE. CHP	0. 1uF 16V
2218	US044220	C. CE. CHP	0. 022uF 25V
2219	US044220	C. CE. CHP	0. 022uF 25V
2220	UR828100	C. EL	100uF 10V
2221	US135100	C. CE. CHP	0. 1uF 16V
2222	US126100	C. CE. CHP	1uF 10V
2223	US044220	C. CE. CHP	0. 022uF 25V
2224	US044220	C. CE. CHP	0. 022uF 25V
2225	UR828100	C. EL	100uF 10V
2226	UR828100	C. EL	100uF 10V
2227	UR837100	C. EL	10uF 16V
2228	US063100	C. CE. M. CHP	1000pF 50V
2229	US062100	C. CE. CHP	100pF 50V
2230	US063100	C. CE. M. CHP	1000pF 50V
2231	US135100	C. CE. CHP	0. 1uF 16V
2232	UR837100	C. EL	10uF 16V
2233	US061470	C. CE. CHP	47pF 50V
2234	US135100	C. CE. CHP	0. 1uF 16V
2235	US061470	C. CE. CHP	47pF 50V
2236	UR819100	C. EL	1000uF 6. 3V
2237	UR838470	C. EL	470uF 16V
3112	HX610400	R. MTL. CHP	8. 2KΩ 1/16W
3205	HX610400	R. MTL. CHP	8. 2KΩ 1/16W
3231	HX610400	R. MTL. CHP	8. 2KΩ 1/16W

* New Parts

Schm Ref.	PART NO.	Description	Remarks
3234	HV755100	R. CAR. FP	100Ω 1/4W
3235	HV755100	R. CAR. FP	100Ω 1/4W
3204	HV754470	R. CAR. FP	47Ω 1/4W
3216	HV756270	R. CAR. FP	2. 7KΩ 1/4W
3214	HV457330	R. CAR. FP	33KΩ 1/4W
3208	HX609130	R. MTL. CHP	100K 1/10W
3230	HX609130	R. MTL. CHP	100K 1/10W
3239	HX609130	R. MTL. CHP	100K 1/10W
5100	AAx22140	COIL	DSS306
5101	AAx22140	COIL	DSS306
5102	AAx22140	COIL	DSS306
5200	AAx22120	COIL	100uH
5201	AAx22140	COIL	DSS306
5202	AAx22140	COIL	DSS306
6100	AAx22640	DIODE. CHP	UDZ15B
6101	AAx22640	DIODE. CHP	UDZ15B
6102	AAx22640	DIODE. CHP	UDZ15B
6103	AAx22640	DIODE. CHP	UDZ15B
6104	AAx22640	DIODE. CHP	UDZ15B
6203	AAx22640	DIODE. CHP	UDZ15B
6204	AAx22640	DIODE. CHP	UDZ15B
7200	AAx21900	IC	UDA1334TS/NI
7201	AAx21660	IC	LM833D
7202	AAx21660	IC	LM833D
7203	AAx21610	IC	LF33CV
7204	AAx22270	L. EMIT	GP1F32T
7410	AAx22740	TR. CHP	BC847B
7411	AAx22740	TR. CHP	BC847B
7412	AAx22740	TR. CHP	BC847B
7413	AAx22730	TR. CHP	BC856B
7414	AAx22740	TR. CHP	BC847B
7415	AAx22740	TR. CHP	BC847B
7416	AAx22740	TR. CHP	BC847B
7417	AAx22730	TR. CHP	BC856B
7418	AAx22740	TR. CHP	BC847B
7419	AAx22740	TR. CHP	BC847B
7420	AAx22730	TR. CHP	BC856B
7421	AAx22740	TR. CHP	BC847B
7422	AAx22740	TR. CHP	BC847B
7423	AAx22730	TR. CHP	BC856B
7424	AAx22740	TR. CHP	BC847B
7425	AAx22740	TR. CHP	BC847B
7426	AAx22740	TR. CHP	BC847B
7427	AAx22730	TR. CHP	BC856B
7501	AAx22780	TR. CHP	BC817-25
7502	AAx22780	TR. CHP	BC817-25
7503	AAx22740	TR. CHP	BC847B
7504	AAx22780	TR. CHP	BC817-25
7505	AAx22740	TR. CHP	BC847B
7506	AAx22780	TR. CHP	BC817-25
7507	AAx22780	TR. CHP	BC817-25
7508	AAx22740	TR. CHP	BC847B
7509	AAx22730	TR. CHP	BC856B
7510	AAx22740	TR. CHP	BC847B
7511	AAx22740	TR. CHP	BC847B
7512	AAx22780	TR. CHP	BC817-25
*	AAx29580	P. C. B.	AV(GB)
1001	AAx22220	CN	BMV 16P FFC
1002	AAx29760	TERM. SCART	21P
1003	AAx22350	JACK. DIN	4P MDIN
1005	AAx22300	JACK. PIN	3P YKC21-3930

* New Parts

DVD-S520/DV-S5450

P. C. B. AV

Schm Ref.	PART NO.	Description	Remarks
1010	AAx22230	CN	BMV 22P FFC
1011	AAx30050	JACK. PIN	2P YKC21-3416
1012	AAx30050	JACK. PIN	2P YKC21-3416
2101	UJ729470	C. EL	4700uF 10V
2103	UR819100	C. EL	1000uF 6.3V
2104	UR819100	C. EL	1000uF 6.3V
2105	UR848100	C. EL	100uF 25V
2106	US135100	C. CE. CHP	0.1uF 16V
2107	UB445470	C. CE. M. CHP	0.47uF 16V
2108	UR848100	C. EL	100uF 25V
2109	UR819100	C. EL	1000uF 6.3V
2110	US062220	C. CE. CHP	220pF 50V
2111	US044220	C. CE. CHP	0.022uF 25V
2112	US062100	C. CE. CHP	100pF 50V
2113	US062220	C. CE. CHP	220pF 50V
2114	UR848100	C. EL	100uF 25V
2115	US062220	C. CE. CHP	220pF 50V
2116	US062220	C. CE. CHP	220pF 50V
2117	US062220	C. CE. CHP	220pF 50V
2200	US135100	C. CE. CHP	0.1uF 16V
2201	UR837470	C. EL	47uF 16V
2202	UR837470	C. EL	47uF 16V
2203	US135100	C. CE. CHP	0.1uF 16V
2204	UR828100	C. EL	100uF 10V
2205	UR848100	C. EL	100uF 25V
2206	UR837470	C. EL	47uF 16V
2207	US135100	C. CE. CHP	0.1uF 16V
2208	UR837100	C. EL	10uF 16V
2209	UB445470	C. CE. M. CHP	0.47uF 16V
2210	US135100	C. CE. CHP	0.1uF 16V
2211	UR848100	C. EL	100uF 25V
2212	US063100	C. CE. M. CHP	1000pF 50V
2213	US135100	C. CE. CHP	0.1uF 16V
2214	US062100	C. CE. CHP	100pF 50V
2215	US063100	C. CE. M. CHP	1000pF 50V
2216	UR837100	C. EL	10uF 16V
2217	US135100	C. CE. CHP	0.1uF 16V
2218	US044220	C. CE. CHP	0.022uF 25V
2219	US044220	C. CE. CHP	0.022uF 25V
2220	UR848100	C. EL	100uF 25V
2221	US135100	C. CE. CHP	0.1uF 16V
2222	US126100	C. CE. CHP	1uF 10V
2223	US044220	C. CE. CHP	0.022uF 25V
2224	US044220	C. CE. CHP	0.022uF 25V
2225	UR848100	C. EL	100uF 25V
2226	UR848100	C. EL	100uF 25V
2227	UR837100	C. EL	10uF 16V
2228	US063100	C. CE. M. CHP	1000pF 50V
2229	US062100	C. CE. CHP	100pF 50V
2230	US063100	C. CE. M. CHP	1000pF 50V
2231	US135100	C. CE. CHP	0.1uF 16V
2232	UR837100	C. EL	10uF 16V
2233	US061470	C. CE. CHP	47pF 50V
2234	US135100	C. CE. CHP	0.1uF 16V
2235	US061470	C. CE. CHP	47pF 50V
2236	UR819100	C. EL	1000uF 6.3V
2237	UR838470	C. EL	470uF 16V
2243	US062220	C. CE. CHP	220pF 50V
2244	US062220	C. CE. CHP	220pF 50V
2249	US061220	C. CE. CHP	22pF 50V
3142	HX610400	R. MTL. CHP	8.2KΩ 1/16W
3205	HX610400	R. MTL. CHP	8.2KΩ 1/16W
3231	HX610400	R. MTL. CHP	8.2KΩ 1/16W

* New Parts

Schm Ref.	PART NO.	Description	Remarks
3239	HX609130	R. MTL. CHP	100K 1/10W
3145	HV757100	R. CAR. FP	10KΩ 1/4W
3159	HV755100	R. CAR. FP	100Ω 1/4W
3234	HV755100	R. CAR. FP	100Ω 1/4W
3235	HV755100	R. CAR. FP	100Ω 1/4W
3204	HV754470	R. CAR. FP	47Ω 1/4W
3203	HV755680	R. CAR. FP	680Ω 1/4W
3228	HV755680	R. CAR. FP	680Ω 1/4W
3144	HV757150	R. CAR. FP	15KΩ 1/4W
3143	HV457220	R. CAR. FP	22KΩ 1/4W
3221	HV756270	R. CAR. FP	2.7KΩ 1/4W
3223	HV756270	R. CAR. FP	2.7KΩ 1/4W
3229	HV756270	R. CAR. FP	2.7KΩ 1/4W
3149	HV457470	R. CAR. FP	47KΩ 1/4W
5200	AAx22120	COIL	100uH
6102	AAx22640	DIODE. CHP	UDZ15B
6103	AAx22640	DIODE. CHP	UDZ15B
6104	AAx22640	DIODE. CHP	UDZ15B
6105	AAx22640	DIODE. CHP	UDZ15B
6106	AAx22640	DIODE. CHP	UDZ15B
6107	AAx22640	DIODE. CHP	UDZ15B
6203	AAx22640	DIODE. CHP	UDZ15B
6204	AAx22640	DIODE. CHP	UDZ15B
7200	AAx21900	IC	UDA1334TS/NI
7201	AAx21660	IC	LM833D
7202	AAx21660	IC	LM833D
7203	AAx21610	IC	LF33CV
7204	AAx22270	L. EMIT	GP1F32T
7401	AAx22740	TR. CHP	BC847B
7402	AAx22740	TR. CHP	BC847B
7403	AAx22740	TR. CHP	BC847B
7404	AAx22730	TR. CHP	BC856B
7405	AAx22740	TR. CHP	BC847B
7406	AAx22740	TR. CHP	BC847B
7407	AAx22730	TR. CHP	BC856B
7408	AAx22740	TR. CHP	BC847B
7409	AAx22740	TR. CHP	BC847B
7413	AAx22730	TR. CHP	BC856B
7414	AAx22740	TR. CHP	BC847B
7415	AAx22740	TR. CHP	BC847B
7416	AAx22730	TR. CHP	BC856B
7417	AAx22740	TR. CHP	BC847B
7418	AAx22740	TR. CHP	BC847B
7419	AAx22730	TR. CHP	BC856B
7420	AAx22730	TR. CHP	BC856B
7421	AAx22740	TR. CHP	BC847B
7422	AAx22740	TR. CHP	BC847B
7423	AAx22740	TR. CHP	BC847B
7501	AAx22780	TR. CHP	BC817-25
7502	AAx22780	TR. CHP	BC817-25
7503	AAx22740	TR. CHP	BC847B
7504	AAx22780	TR. CHP	BC817-25
7505	AAx22740	TR. CHP	BC847B
7506	AAx22780	TR. CHP	BC817-25
7507	AAx22780	TR. CHP	BC817-25
7508	AAx22740	TR. CHP	BC847B
7509	AAx22730	TR. CHP	BC856B
7510	AAx22740	TR. CHP	BC847B
7511	AAx22740	TR. CHP	BC847B
7512	AAx22780	TR. CHP	BC817-25

* New Parts

P. C. B. DISPLAY & P. C. B. VFM & P. C. B. POWER

Schm Ref.	PART NO.	Description	Remarks
	AAAX29610	P. C. B.	DISPLAY (UCARTP)
	AAAX29620	P. C. B.	DISPLAY (GB)
2	AAAX30160	HOLDER	3139 244 01321
1100	AAAX22420	SW	4822 276 13775
1101	AAAX22420	SW	4822 276 13775
1102	AAAX22420	SW	4822 276 13775
1106	AAAX22420	SW	4822 276 13775
1107	AAAX22420	SW	4822 276 13775
1108	AAAX22420	SW	4822 276 13775
1109	AAAX22420	SW	4822 276 13775
1110	AAAX23300	RSNR. CRYST	8MHz CSTS
1111	AAAX22420	SW	(GB) 4822 276 13775
1113	AAAX30360	FL. DSPLY	11-MT-126GNK (UCARTP)
1113	AAAX30370	FL. DSPLY	HNV-11SS28T DV (GB)
1115	AAAX29720	CN	6P (UCART)
1115	AAAX22320	CN	4P (GB)
1117	AAAX22320	CN	4P
1118	AAAX22340	CN	5P B5B-PH-K
1120	AAAX22400	SW	2P 100mA 30V (UCARTP)
1205	AAAX22330	CN	4P
2105	US034330	C. CE. CHP	0. 033uF 16V
2106	UR848100	C. EL	100uF 25V (UCARTP)
2107	UD114470	C. CE. M. CHP	0. 047uF 50V
2108	UD114470	C. CE. M. CHP	0. 047uF 50V
2109	UD114470	C. CE. M. CHP	0. 047uF 50V
2110	UD114470	C. CE. M. CHP	0. 047uF 50V
2111	UD114470	C. CE. M. CHP	0. 047uF 50V
2114	US061220	C. CE. CHP	22pF 50V
2115	US061220	C. CE. CHP	22pF 50V
2116	US034330	C. CE. CHP	0. 033uF 16V
2122	US034330	C. CE. CHP	0. 033uF 16V
2123	UR848100	C. EL	100uF 25V (UCARTP)
2124	UR857220	C. EL	22uF 35V
2125	US061220	C. CE. CHP	22pF 50V
2126	UR837100	C. EL	10uF 16V
2128	US063100	C. CE. CHP	1000pF 50V
2129	UR857220	C. EL	22uF 35V
2130	UR867470	C. EL	47uF 50V
2201	US034330	C. CE. CHP	0. 033uF 16V
s 3102	HX609650	R. MTL. CHP	47KΩ 1/10W (GB)
3104	HX609130	R. MTL. CHP	100K 1/10W (GB)
3144	HX609130	R. MTL. CHP	100K 1/10W
6100	AAAX22630	DIODE. CHP	BAS316 (GB)
6101	AAAX29920	DIOD. Z. CHP	UDZ6. 2B TE-17
6102	AAAX29910	DIOD. Z. CHP	UDZS8. 2B
6104	AAAX22630	DIODE. CHP	BAS316
6200	AAAX21910	LED	LTL-16KPE-P
7101	AAAX22740	TR. CHP	BC847B (GB)
7104	AAAX21530	IC	TMP87CH74F
7105	AAAX29960	TR	BC337-25
7106	AAAX22850	TR	BC327
7107	AAAX22740	TR. CHP	BC847B
7108	AAAX22740	TR. CHP	BC847B
7109	AAAX22730	TR. CHP	BC856B
7110	AAAX30210	L. DTCT	GP1U28XP
7112	AAAX21670	IC	MC79L24ACP
	AAAX30410	P. S. U.	230V (GB)
* 0101	AAAX29730	CN	B2P3-VH
* 0120	AAAX22960	HOLDER. FUS	2P
* 0205	AAAX29710	CN	12P BMW P=2. 5mm
0208	AAAX22320	CN	4P

* New Parts

Schm Ref.	PART NO.	Description	Remarks
1120	AAAX22950	FUSE	2. 5A 250V
* 2120	AAAX30300	C. CE. SAFTY	0. 1uF 275V
* 2121	AAAX29640	C. EL	47uF 400V
2127	AAAX23250	C. CE. SAFTY	470pF 1KV
* 2130	AAAX30310	C. CE. SAFTY	1000pF 250V
* 2131	AAAX30310	C. CE. SAFTY	1000pF 250V
2134	UR867470	C. EL	47uF 50V
2135	UR866220	C. EL	2. 2uF 50V
2141	UR866220	C. EL	2. 2uF 50V
2143	AAAX22490	C. CE. CHP	0. 1uF 50V
2145	AAAX22520	C. CE. CHP	4700pF 63V
2146	AAAX22490	C. CE. CHP	0. 1uF 50V
2150	AAAX22490	C. CE. CHP	0. 1uF 50V
2156	AAAX22500	C. CE. CHP	330pF 63V
2157	AAAX22510	C. CE. CHP	470pF 50V
2202	AAAX22490	C. CE. CHP	0. 1uF 50V
2210	UR829220	C. EL	2200uF 10V
2230	UR839100	C. EL	1000uF 16V
2232	UR838100	C. EL	100uF 16V
2235	US034330	C. CE. CHP	0. 033uF 16V
2238	UR838100	C. EL	100uF 16V
2239	UR838100	C. EL	100uF 16V
2240	UR848470	C. EL	470uF 25V
2250	UR838220	C. EL	220uF 16V
2259	UR838100	C. EL	100uF 16V
2260	UR867220	C. EL	22uF 50V
* 2299	AAAX29890	C. CE. CHP	0. 022uF 63V
3111	HV754100	R. CAR. FP	10Ω 1/4W
* 3120	AAAX30010	S. ABSOEBER	DC 1MA/423V S
3153	HV757150	R. CAR. FP	15KΩ 1/4W
3233	HL313220	R. MTL. OXD	2. 2Ω 1W
3132	HL213100	R. MTL. OXD	1Ω 1W
3201	HV754100	R. CAR. FP	10Ω 1/4W
3135	HV754150	R. CAR. FP	15Ω 1/4W
3155	HV755330	R. CAR. FP	330Ω 1/4W
3140	HV755560	R. CAR. FP	560Ω 1/4W
* 3263	HV75618	R. CAR. FP	1. 8KΩ 1/4W
* 3123	HV457560	R. CAR. FP	56KΩ 1/4W
* 3134	HV457560	R. CAR. FP	56KΩ 1/4W
3127	HV753100	R. MTL. OXD	1Ω 1/4W
3128	HV753100	R. MTL. OXD	1Ω 1/4W
3262	HV755220	R. CAR. FP	220Ω 1/4W
5120	AAAX23620	COIL	LINE FILTER
5125	AAAX22040	COIL	100mH
* 5131	AAAX29990	TRANS	
* 5135	AAAX29700	COIL	27uH
* 5210	AAAX29670	COIL	LHL08 S
* 5222	AAAX29680	COIL	47uH
* 5231	AAAX29670	COIL	LHL08 S
5240	AAAX22100	COIL	1uH 4x9. 8
5260	AAAX22060	COIL	10uH 2. 3x3. 4
* 6118	AAAX29790	DIODE	1N4006
* 6119	AAAX29790	DIODE	1N4006
* 6120	AAAX29790	DIODE	1N4006
* 6121	AAAX29790	DIODE	1N4006
* 6129	AAAX29830	DIODE	PDZ22B
* 6132	AAAX29780	DIODE	BAV21
* 6133	AAAX29780	DIODE	BAV21
6140	AAAX22560	DIODE	1N4148
6141	AAAX22540	DIODE	UDZ18B
6150	AAAX22530	DIODE	UDZ4. 7B
6210	AAAX22550	DIODE	BYW98-200-C1
* 6230	AAAX29810	DIODE	BYW95C
4822 253 30383			
4822 121 10711			
2222 151 90048			
4822 122 50116			
4822 126 13841			
4822 126 13841			
4822 124 22652			
4822 124 22652			
4822 126 14585			
5322 126 10223			
4822 126 14585			
4822 126 14585			
5322 122 31863			
5322 122 32268			
4822 126 14585			
2020 012 93728			
066840			
4822 124 81021			
4822 126 14549			
4822 124 81021			
4822 124 81021			
4822 124 41545			
4822 124 81021			
4822 124 81151			
5322 122 32654			
2322 595 90023			
ERDS2FJ331			
ERDS2FJ561			
4822 116 52249			
ERDS2FJ563			
ERDS2FJ563			
ERDS2FJ221			
4822 157 11846			
4822 157 11411			
3128 138 39631			
4822 157 70698			
2422 535 94638			
4822 156 20966			
2422 535 94638			
4822 157 51195			
4822 157 11517			
4822 130 31603			
4822 130 31603			
4822 130 31603			
4822 130 31603			
9340 548 67115			
4822 130 30842			
4822 130 30842			
4822 130 30621			
4822 130 11152			
4822 130 11148			
4822 130 11584			
4822 130 41602			

* New Parts

DVD-S520/DV-S5450

P. C. B. POWER

Schm Ref.	PART NO.	Description	Remarks
* 6233	AAx29800	DIODE BZY79-B4V7	4822 130 34174
6241	AAx22550	DIODE BYW98-200-C1	4822 130 11584
6250	AAx22580	DIODE BYD33D	4822 130 42488
6261	AAx22590	DIODE BYD33J	4822 130 42606
7125	AAx21500	FET STP3NB60FP	4822 130 11417
* 7131	AAx30080	PHOTO. CPL TCET1102-G	9322 149 04682
7141	AAx22880	IC BC557B	4822 130 44568
7145	AAx21820	IC UC3842A	9322 145 88682
* 7150	AAx29970	TR BC547	4822 130 44257
7201	AAx21710	IC TL431CLPST	4822 209 81397
7235	AAx22870	TR BC847	4822 130 42705
* 7238	AAx29450	FET IRLML2803	5322 130 11197
7255	AAx22860	TR BC337	4822 130 40855
* 7256	AAx29980	TR BC857C	5322 130 42756
* 7257	AAx29980	TR BC857C	5322 130 42756
	RD350000	R. CAR. CHP 0Ω 1/10W	
	RD353100	R. CAR. CHP 1Ω 1/10W	
	RD353220	R. CAR. CHP 2.2Ω 1/10W	
	RD353470	R. CAR. CHP 4.7Ω 1/10W	
	RD354330	R. CAR. CHP 33Ω 1/10W	
	RD354470	R. CAR. CHP 47Ω 1/10W	
	RD355100	R. CAR. CHP 100Ω 1/10W	
	RD355390	R. CAR. CHP 390Ω 1/10W	
	RD356100	R. CAR. CHP 1KΩ 1/10W	
	RD357220	R. CAR. CHP 22KΩ 1/10W	
	RD357360	R. CAR. CHP 36KΩ 1/10W	
	HX611040	R. CAR. CHP 0Ω 1/16W	
	HX610750	R. CAR. CHP 1Ω 1/16W	
	NX703320	R. CAR. CHP 2.2Ω 1/16W	ERJ3GEYJ2R2
	HX611160	R. CAR. CHP 10Ω 1/16W	
	HX610090	R. CAR. CHP 22Ω 1/16W	ERJ3GEYJ220
	HX611150	R. CAR. CHP 47Ω 1/16W	
	AAx06470	R. CAR. CHP 68Ω 1/16W	ERJ3GEYJ680
	AAx15900	R. CAR. CHP 75Ω 1/16W	ERJ3RED750
	HX610900	R. CAR. CHP 100Ω 1/16W	
	AAx15800	R. CAR. CHP 150Ω 1/16W	ERJ3GEYF151
	HX610960	R. CAR. CHP 220Ω 1/16W	1305810918
	HX611120	R. CAR. CHP 270Ω 1/16W	
	HX610170	R. CAR. CHP 330Ω 1/16W	ERJ3GEYJ331
	HX610890	R. CAR. CHP 470Ω 1/16W	
	HX611010	R. CAR. CHP 560Ω 1/16W	1305810927
	HX610910	R. CAR. CHP 1kΩ 1/16W	
	HX611090	R. CAR. CHP 1.5kΩ 1/16W	
	HX610110	R. CAR. CHP 2.2KΩ 1/16W	4822 050 12202
	HX611140	R. CAR. CHP 2.7kΩ 1/16W	
	HX610980	R. CAR. CHP 3.3kΩ 1/16W	
	AAx17770	R. CAR. CHP 3.9KΩ 1/16W	VRSCY1JB392F
	HX611080	R. CAR. CHP 4.7kΩ 1/16W	
	HX611030	R. CAR. CHP 6.8kΩ 1/16W	
	HX610920	R. CAR. CHP 10kΩ 1/16W	
	HX610780	R. CAR. CHP 12kΩ 1/16W	
	HX610950	R. CAR. CHP 15KΩ 1/16W	
	HX611110	R. CAR. CHP 22kΩ 1/16W	
	HX611130	R. CAR. CHP 27kΩ 1/16W	
	AAx17750	R. CAR. CHP 33KΩ 1/16W	VRSCY1JB333F
	AAx06590	R. CAR. CHP 39KΩ 1/16W	ERJ3RBD393
	HX611070	R. CAR. CHP 1MΩ 1/16W	

* New Parts

Schm Ref.	PART NO.	Description	Remarks

* New Parts

EXPLODED VIEW

When disassembling, use the special screw driver with tip shape in figure.

T10  2.7 mm for screws with 33, 35 and 36

T6  1.7 mm for removing MONO board (18-2) from DVD Mechanism (18-1)

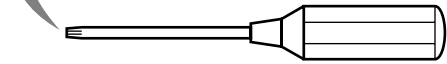

Note) The screw to fix the MONO board 18-2 to the DVD mechanism 18-1 is not available.

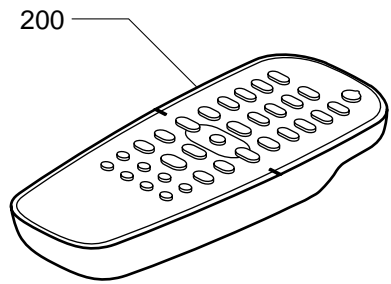

Note) The Lid is not available.

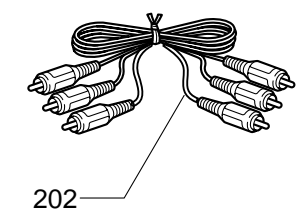
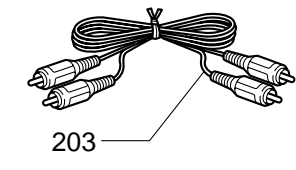
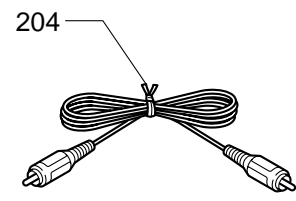
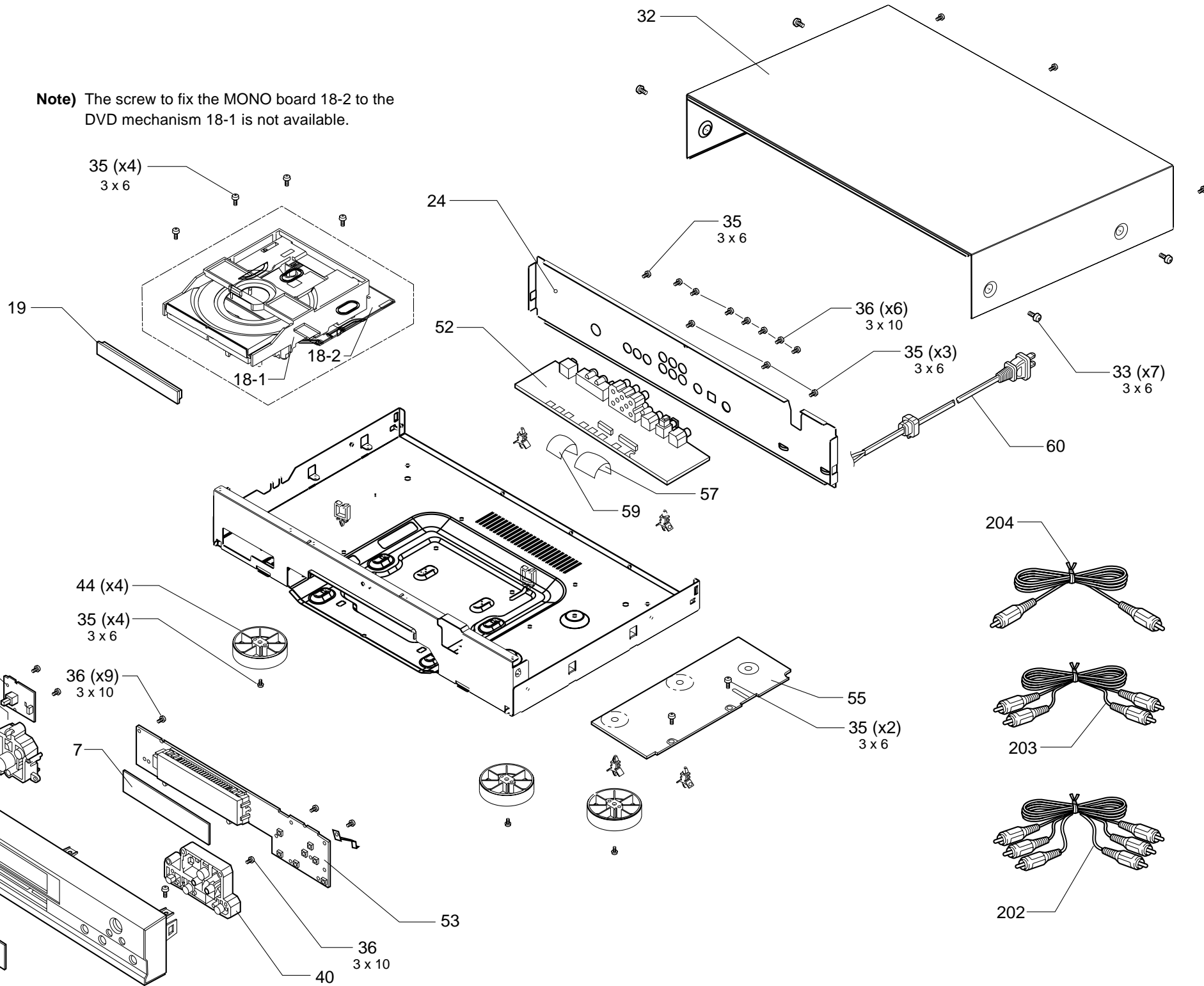

5

6

7

MECHANICAL PARTS

Ref. No.	PART NO.	Description	Remarks	Markets		
*	1	AA30140	FRONT PANEL	S520BL	3139 247 54561	UCAP
*	1	AA30150	FRONT PANEL	S520BL	3139 247 54571	GB
*	1	AA30090	FRONT PANEL	S520GD	3139 247 54351	RT
*	1	AA30110	FRONT PANEL	S520GD	3139 247 54441	G
*	1	AA30130	FRONT PANEL	S520TI	3139 247 54491	G
*	1	AA30120	FRONT PANEL	S5450BL	3139 247 54461	UA
*	1	AA30100	FRONT PANEL	S5450SI	3139 247 54391	U
*	2	AA322900	BADGE YAMAHA	S520BL/TI, S5450SI	3139 240 00061	
*	2	AA322910	BADGE YAMAHA	S520GD, S5450BL	3139 240 00071	
*	4	AA329630	WINDOW	GRAYSMOKE	3139 244 01631	
*	5	AA322920	BUTTON/POWER	S520BL	3139 247 52381	UCAR
*	5	AA322930	BUTTON/POWER	S520GD	3139 247 52701	RT
*	5	AA322940	BUTTON/POWER	S5450BL	3139 247 52711	UA
*	5	AA330030	BUTTON/POWER	S5450SI	3139 247 54411	U
*	5	AA322430	BUTTON/STANDBY	S520BL	3139 247 52391	GB
*	5	AA322440	BUTTON/STANDBY	S520GD	3139 247 52401	G
*	5	AA329770	BUTTON/STANDBY	S520TI	3139 247 54511	G
*	7	AA330060	FL FILTER		3139 243 10131	
			DVD MODULE	SD3.0 NON EURO	3139 248 70841	not available
			DVD MODULE	SD3.0 EURO	3139 248 70381	not available
*	18-1	AA321470	DVD MECHANISM (BASIC ENGINE)	VAL6011/04	9305 023 61104	
*	18-2	AA329590	P. C. B. ASS'Y	MONO BOARD	3139 247 10111	UCARTP
*	18-2	AA329600	P. C. B. ASS'Y	MONO BOARD	3139 247 10161	GB
*	19	AA323100	COVER TRAY	S520BL	3139 247 52451	
*	19	AA323110	COVER TRAY	S520GD	3139 247 52461	
*	19	AA330190	COVER TRAY	S520TI	3139 247 54501	
*	19	AA323130	COVER TRAY	S5450BL	3139 247 52731	
*	19	AA330180	COVER TRAY	S5450SI	3139 247 54401	
*	24	AA330260	REAR PANEL	S520	3139 247 54531	UC
*	24	AA330230	REAR PANEL	S520	3139 247 54361	R
*	24	AA330240	REAR PANEL	S520	3139 247 54371	T
*	24	AA330270	REAR PANEL	S520	3139 247 54541	A
*	24	AA330220	REAR PANEL	S520	3139 247 54331	GB
*	24	AA330280	REAR PANEL	S520	3139 247 54551	P
*	24	AA330250	REAR PANEL	S5450	3139 247 54471	U
*	24	AA330290	REAR PANEL	S5450	3139 247 54581	A
*	32	AA322820	TOP COVER	S520BL, S5450BL	3139 247 50341	
*	32	AA322830	TOP COVER	S520GD	3139 247 52481	
*	32	AA322840	TOP COVER	S520TI, S5450SI	3139 247 52491	
*	33	AA323640	PAN HEAD TORX S-TITE SCREW	3x6 ZN-BL	4822 502 13988	
*	33	AA323650	PAN HEAD TORX S-TITE SCREW	3x6 NI	2511 077 01039	
*	35	AA323640	PAN HEAD TORX S-TITE SCREW	3x6 ZN-BL	4822 502 13988	
*	36	AA323630	PAN HEAD TORX P-TITE SCREW	3x10 ZN-BL	4822 502 14109	
*	40	AA323330	BUTTON/CONTROL	S520BL	3139 247 52421	
*	40	AA323340	BUTTON/CONTROL	S520GD	3139 247 52431	
*	40	AA330400	BUTTON/CONTROL	S520TI	3139 247 54521	
*	40	AA323360	BUTTON/CONTROL	S5450BL	3139 247 52721	
*	40	AA330390	BUTTON/CONTROL	S5450SI	3139 247 54421	
*	44	AA323270	FOOT ASS'Y	S520BL, S5450SI	3139 247 50750	UCAP
*	44	AA323280	FOOT ASS'Y	S520BL, S520TI	3139 247 51261	GB
*	44	AA323290	FOOT ASS'Y	S520GD	3139 247 51461	G
*	44	AA330350	FOOT ASS'Y	S520GD	3139 247 51451	RT
*	44	AA330340	FOOT ASS'Y	S5450BL	3139 247 51220	U
*	52	AA329570	P. C. B. ASS'Y	AV	3139 248 80881	UCARTP
*	52	AA329580	P. C. B. ASS'Y	AV	3139 248 80891	GB
*	53	AA329610	P. C. B. ASS'Y	DISPLAY	3139 248 80951	UCARTP
*	53	AA329620	P. C. B. ASS'Y	DISPLAY	3139 248 80961	GB
*	55	AA330430	POWER SUPPLY UNIT	VFM 2001 US 120V	3139 248 70421	UC
*	55	AA330420	POWER SUPPLY UNIT	VFM WR	3122 427 22600	ARTP
*	55	AA330410	POWER SUPPLY UNIT	VFM EURO 230V	3122 427 22572	GB

* New Parts

DVD-S520/DV-S5450

Ref. No.	PART NO.	Description	Remarks	Markets
57	AAX22990	FLEXIBLE FOIL CONNECTION	FFC 22P 130mm	3139 110 34220
59	AAX23000	FLEXIBLE FOIL CONNECTION	FFC 16P 130mm	3139 110 34230
⚠ 60	V2363800	POWER CORD ASS'Y		UC
⚠ 60	VZ542500	POWER CORD ASS'Y		RTP
⚠ 60	V2296800	POWER CORD ASS'Y		A
⚠ 60	VN363700	POWER CORD ASS'Y		G
⚠ 60	VV437300	POWER CORD ASS'Y		B

Ref. No.	PART NO.	Description	Remarks	Markets
* 200	AAX30200	ACCESSORY REMOTE CONTROL TRANSMITTER	RC19133004/01H	3139 228 89671
202	AAX23450	AUDIO/VIDEO CORD	YE/RD/WH 1.5m 1pc	2422 076 00304
203	AAX21980	AUDIO CORD	RD/WH 1.5m 1pc	3103 308 92611
204	AAX22970	VIDEO CORD	YE 1.5m 1pc	3104 108 45432

■ DVD MECHANISM ASS'Y

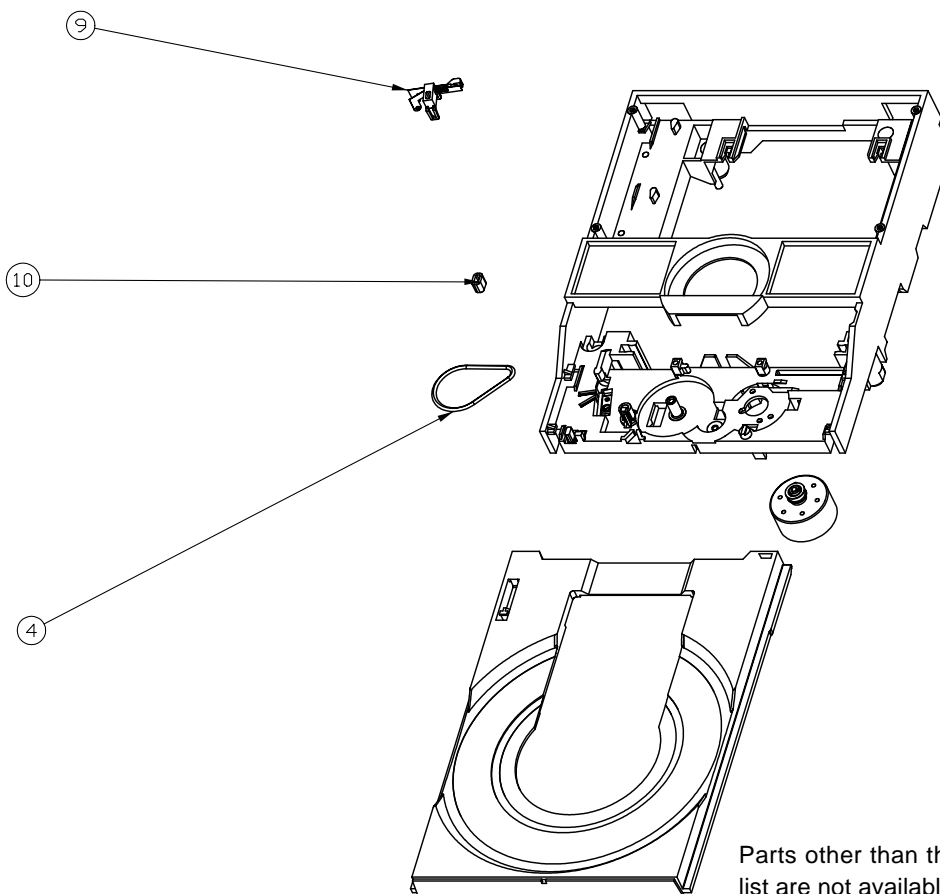

Ref. No.	PART NO.	Description	Remarks	Markets
* 4	AAX21470	DVD MECHANISM (BASIC ENGINE)		9305 023 61102
* 9	AAX23070	BELT/DRIVING		4822 358 10266
* 10	AAX22410	SWITCH/OTHERS		3139 198 80010
* 10	AAX23210	RING	TULE	4822 532 13097
* 10		TRAY		3139 194 00270
* 10		MOTOR	DC <=37.5W	3139 197 50060

* New Parts

1 ■ REMOTE CONTROL TRANSMITTER

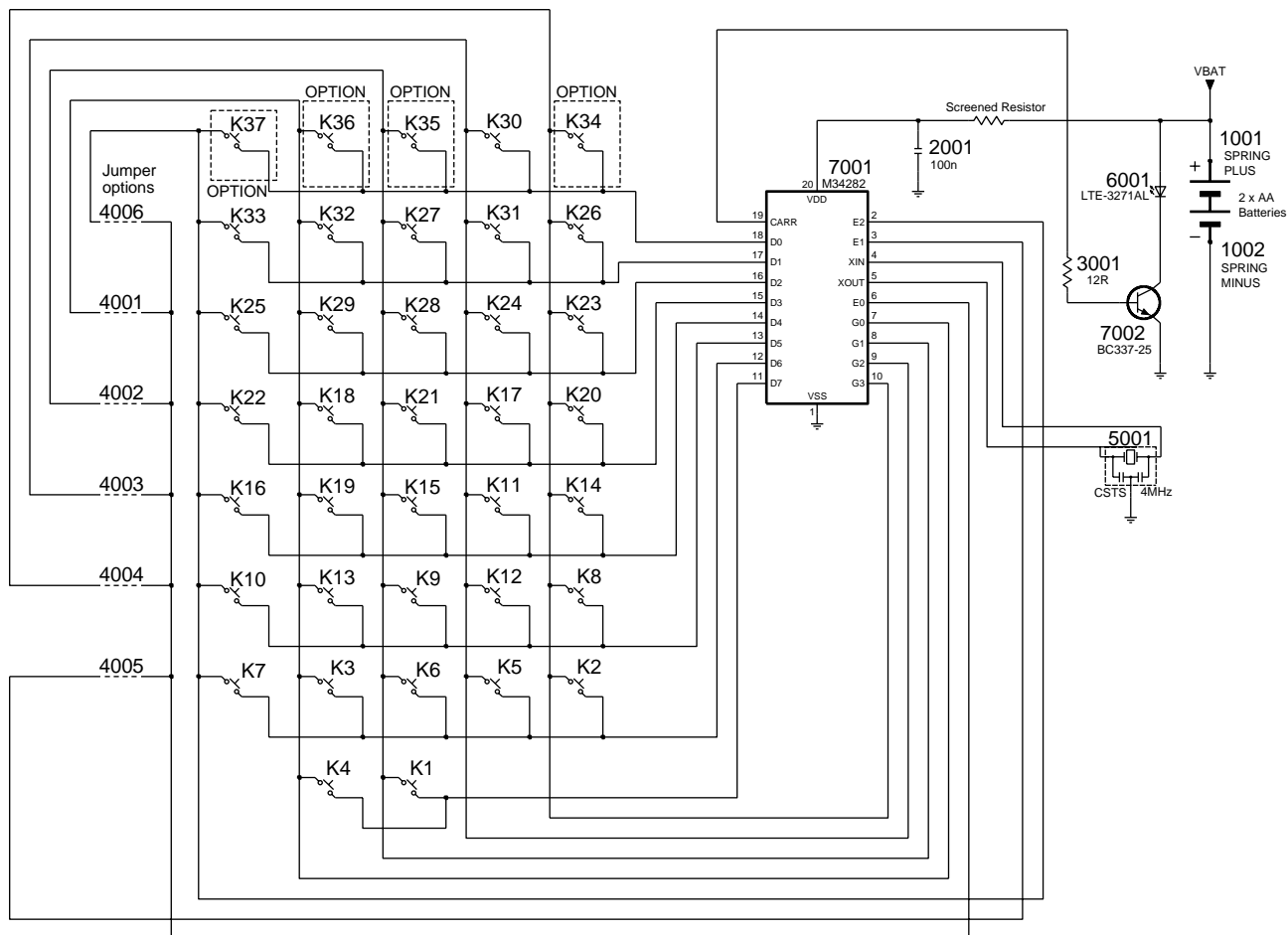

DVD-S520/DV-S5450

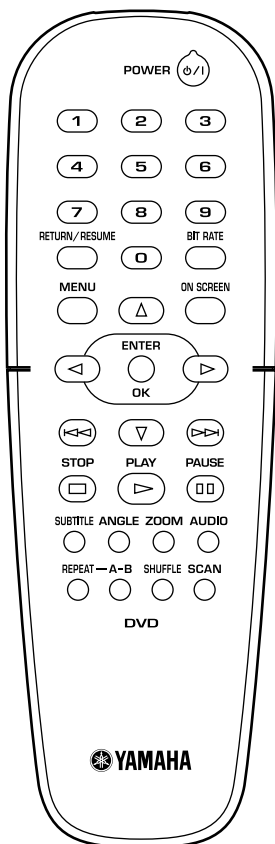

Protocol Type: RC6 Mode 0

Key No.	RC Key id	Hexadecimal code
1	POWER ϕ /I	C
2	1	1
3	2	2
4	3	3
5	4	4
6	5	5
7	6	6
8	7	7
9	8	8
10	9	9
11	RETURN/RESUME	83
12	0	0
13	BIT RATE	EF
14	MENU	54
15	CURSOR UP Δ	58
16	ON SCREEN	82
17	CURSOR LEFT \triangleleft	5A
18	OK	5C
19	CURSOR RIGHT \triangleright	5B
20	PREVIOUS \ll	21
21	CURSOR DOWN ∇	21
22	NEXT \gg	20
23	STOP \square	31
24	PLAY \triangleright	2C
25	PAUSE $\square\square$	30
26	SUBTITLE	4B
27	ANGLE	85
28	ZOOM	F7
29	AUDIO	4E
30	REPEAT	1D
31	A/B REPEAT	3B
32	SHUFFLE	1C
33	SCAN	2A

DVD-S520/DV-S5450

